

FORM 80A - Rule 80

AFFIDAVIT

Court File No. _____

FEDERAL COURT

BETWEEN:

CANADIAN COALITION FOR FIREARM RIGHTS, RODNEY GILTACA, LAURENCE KNOWLES, RYAN STEACY, MACCABEE DEFENSE INC., WOLVERINE SUPPLIES LTD., AND MAGNUM MACHINE LTD.

Applicants

and

ATTORNEY GENERAL OF CANADA and CANADA (ROYAL CANADIAN MOUNTED POLICE)

Respondents

APPLICATION UNDER sections 18 and 18.1 of the *Federal Courts Act*, RSC 1985, c F-7.

AFFIDAVIT

I, Laurence Knowles, of the village of Old Massett in Haida Gwaii, British Columbia, SWEAR (or AFFIRM) THAT:

1. I am an Applicant to the Application in Court File No T-577-20 (the “**Application**”). I am an individual ordinarily resident on the islands of Haida Gwaii in British Columbia. I have personal knowledge of the facts sworn to in this Affidavit, except where I have stated facts that are based on information I have received, and in those cases I believe the information to be true.
2. I am a Status Indian under the *Indian Act*, RSC 1985, c I-5. I am a member of the Haida Nation. I have been hunting and safely using firearms on a nearly daily basis for over 40 years.
3. The Application is a judicial review application and Charter challenge of the *Regulations Amending the Regulations Prescribing Certain Firearms and Other Weapons, Components*

and Parts of Weapons, Accessories, Cartridge Magazines, Ammunition and Projectiles as Prohibited, Restricted or Non-Restricted, SOR/2020-96 (the “**Regulation**”) and the *Order Declaring an Amnesty Period (2020)*, SOR/2020-97 (the “**Amnesty Order**”). The Application is also a judicial review application of certain ad hoc things done by the Royal Canadian Mounted Police (“**RCMP**”), including through the Specialized Firearms Supports Services Unit (“**RCMP SFSS**”) and the Firearms Reference Table (“**FRT**”), as described in the Application. I adopt the defined terms in that Application for the purposes of this my Affidavit.

Background

4. I am 53 years old. I was born in Prince Rupert and reside on the islands of Haida Gwaii, which is the traditional territory of the Haida. Haida Gwaii is approximately 250km north west of Vancouver Island, and 120km west of Prince Rupert. The islands of Haida Gwaii are heavily forested and are mostly wilderness.
5. My family moved to Prince Rupert during World War II, when the majority of Haida women and children were relocated to Prince Rupert because of fear of invasion from Japan. I moved back to Haida Gwaii about 25 years ago.
6. My family were primarily fishers. I was taught to fish at eight years old and I was a commercial fisherman for much of my life, until government regulation, private commercial fishing and fishing tourism devastated this industry in Haida Gwaii and made it impossible for me and my family to continue fishing.
7. Since that time, when employment is necessary for me to earn money, I have primarily worked off-island, as far away as Manitoba. This work involves spending a lot of time far from home, and I do not enjoy that, but it is a necessary part of my life. Aside from off-island work, I do some trapping work, but that is rarely compensated and is usually just for the benefit of the community. I also work as a carver of traditional items, including totem poles.

8. Hunting and trapping are part of the traditional way of life of the Haida people. My hunting helps sustain me, my family, and my community by providing food. My hunting and trapping activities take place primarily in the traditional lands of the Haida people.
9. I was given my first rifle, a single-shot .22, when I was eight years old, when my uncles first taught me to hunt deer. They told me that “a working man should have a rifle”. It is traditional for the Haida to have one’s uncles teach you how to be a man, including how to hunt. This practice is based on Haida tradition that the stories tell us stretches back to before the Ice Age.
10. I, like many other Haida, prefer to eat “soul food”, that is, food that has been hunted or harvested from nature, rather than bought from a store. I find store-bought meat tastes rotten, and I resort to it only when necessary. Also, because Haida Gwaii is so remote, store-bought food -- particularly meat -- is very expensive.
11. For food, I hunt deer, seals, sealions, elk, and moose. The reality of hunting as a food source is that it is not a guarantee. If the hunt is unsuccessful, that can mean a choice between going hungry or resorting to unpleasant store-bought food.
12. This can be more serious in some years, including right now. For example, in 2020, the salmon run is expected to be poor, and I am aware that the government has already placed some restrictions on harvesting salmon, including in areas very close to Haida Gwaii. For example, attached as **Exhibit “A”** is a news article discussing restrictions on salmon harvesting for 2020 in the Skeena watershed, in the Prince Rupert area, just to the east of Haida Gwaii. I am advised by my counsel and believe that the Skeena watershed is part of “Area A”, as determined by the Department of Fisheries and Oceans, which includes all of Haida Gwaii. Attached as **Exhibit “B”** is a map showing the extent of Area A.
13. As a result of these restrictions and the lack of salmon, my community will need to find sustenance alternatives, which means an increased reliance on sustenance hunting as a source of food. If we cannot replace salmon with sustenance hunting, we will have to resort to unpleasant store-bought food. There are already concerns in my community about food shortages as a result of the price of store-bought food and salmon shortages.

14. In addition to sustenance, hunting and trapping have other important functions for the Haida. They are important rituals that connect me with other Haida, my ancestors, and with the land. The Haida use all of the parts of the animal, for food and for traditional clothing, regalia, and artwork. For example, the whiskers of sealions are used for headdresses, the teeth are used for carvings, and the hides are used to make clothing.
15. Trapping -- that is, hunting of small game like deer and rodents -- is also not only part of the way of life of the Haida, but is required to preserve the balance of the environment on Haida Gwaii. The populations of raccoons, deer, and rodents have no natural predators on Haida Gwaii. Without trapping and culling, leaving the populations unchecked, these animals can damage the delicate ecosystems and environment of Haida Gwaii, for example:
 - (a) There are a number of shorebird species at risk, which nest on the ground in Haida Gwaii. Their eggs are targeted by raccoons and rats, which further threatens their populations and could lead to their extinction.
 - (b) Beavers, which were introduced to Haida Gwaii by the government of British Columbia, can cause significant problems in the small rivers throughout Haida Gwaii. They create obstructions in these rivers which inhibit the salmon run. Damage to the salmon run is a significant food security issue for the Haida. Aside from logging, beavers are the largest threat to salmon populations.
 - (c) Due to the logging of old-growth forest on Haida Gwaii, cedar trees -- which are used by Haida for carving and building of traditional longhouses -- are replanted by the forestry industry as saplings. Deer eat the saplings and threaten the continued viability of the cedar forests. The depletion of old-growth cedar due to logging and lack of renewal has led to the increasing use of "conventional" housing materials, which are non-traditional to the Haida, and which suffer from mould problems due to the wet climate.
 - (d) Seals and sealions are beginning to be overpopulated. The government has left it to Aboriginals to manage these populations, I believe due to the political sensitivity

of sanctioning seal hunts. Overpopulation of these species further threatens salmon populations, and therefore the Haida's food security.

Restricted Firearms

16. I own four rifles which have been newly prescribed under the Regulation as “Prohibited Items”: a Stag-10, an ATRS Modern Varmint, and two Polytech M14s (the “**Prohibited Rifles**”).
17. Each of the Prohibited Rifles has a particular use in my hunting and trapping activities. These are expensive guns, particularly given that I only work off-island for money occasionally, and they were selected very carefully and deliberately. These are large and significant purchases for me, and they were made with specific purposes in mind. The combined cost of the Prohibited Rifles is more than my truck, or my boat.
18. The ATRS Modern Varmint is similar to an AR-15, but was non-restricted (prior to the Regulation). I use it primarily to limit the population of raccoons, small deer and other species. As of June 1, 2020, a new ATRS Modern Varmint costs approximately \$3,350, without accessories. I purchased the ATRS when it first entered production in 2015-16. I was working in Saskatchewan and Alberta around that time. Attached hereto as **Exhibit “C”** is a screenshot from Alberta Tactical Rifle Supply's website, showing the cost of this rifle.
19. I bought the Stag-10 from Wolverine Supplies in 2018 in Manitoba, when I was working there. As of June 1, 2020, a new Stag-10 costs approximately \$1,800 without accessories. Attached hereto as **Exhibit “D”** is a screenshot from Wolverine's website, showing the cost of this rifle.
20. The ATRS and the M14s are both good for similar purposes and serve essentially the same function, but the ATRS is, in my opinion, simply a better rifle. I purchased my M14s from Wolverine about 7-8 years ago, for approximately \$800 each.
21. Hunting is a precise activity, and there is a very small window for success. It is essential to have proper, specialized, and well-functioning equipment for this reason. Not just any gun

will do for any hunting purpose. This is especially true when hunting from a boat or a canoe. The waves on a boat reduce your accuracy and mean your first shot does not always land, and if you cannot follow that up with a very quick second or third shot, you will lose the prey. If the first shot lands but only wounds the animal, without a quick second shot, the animal may escape but could suffer for a long time before it dies.

22. There are a number of factors to consider in selecting the right rifle, including the size of the prey, the likely distance of the shot, whether the shot will take place on land or from a boat, whether a second or third shot is typically necessary, and so on. My decisions to purchase the Prohibited Rifles were based on these factors and the specific needs of the kind of hunting I typically do. I could have bought other guns, but these were the ones best suited to my purposes. The non-prohibited guns I own are inadequate for the purposes for which I use the Prohibited Rifles.
23. For example, the ATRS Modern Varmint is particularly well-suited to hunting and trapping from a boat, because of its fast follow-up shot.
24. I use the Stag-10 for larger prey, like sealions, elk, and moose. Sealions are large prey and require a “lot of gun”. The firearm I have best suited for sealions is the Stag-10. Even my other Prohibited Items are not adequate for hunting sealions. The Stag-10 is also particularly well-suited to elk, as the quick follow-up shots along with the excellent balancing of the rifle allow me to potentially get a second animal. Semiautomatic rifles are irreplaceable when I hope to get more than one animal in a herd. Re-racking a shot in a single-shot or bolt-action rifle is too noisy and too slow for this purpose.
25. The M14s are relatively inexpensive semi-automatic rifles which are quite durable, and are well suited to hunting from a boat and on beaches. They are resistant to damage from saltwater, and hunting in boats or on beaches in Haida Gwaii results in a lot of saltwater exposure to firearms.
26. A lot of trapping and wildlife management is done from boats or on beaches, and anything in place of the Prohibited Items would be poor substitutes.

27. Smaller, single-shot non-prohibited rifles such as .22s are useful to teach young people how to hunt, and for some other limited purposes. I occasionally use a .22 when hunting in deep cover as it is possible to get very close to the prey, and the short range of the .22 is not a problem. However, the effectiveness of a .22 diminishes very quickly after about 30 feet of range, and they are basically useless from 50 feet or more away from the target. At that range, you may not even wound a larger animal, much less kill it. This makes .22s poorly-suited to hunting from a boat, at sea, or on-land where cover is sparse, such as on beaches. While I own a number of .22s which remain unprohibited, they are simply not adequate replacements for the Prohibited Rifles.
28. There are additional challenges to hunting on-land in remote areas due to the bear population. Many bears are conditioned to approach the sound of gunshots, as a reliable way to find food. This means on-land hunting requires very quick and efficient killing and dressing of the animals. When a bear approaches after I have made a kill, the presence of food for the bear means I often have to scare it off by firing several warning shots in quick succession. If I am unable to do so, I may lose my prey to the bear or possibly face the serious danger of a confrontation with a bear. A bolt-action rifle is simply not up to this task. In the event of a confrontation, or when the bear is the prey, a powerful semi-automatic rifle is the only way I have to safely and humanely kill the animal. A lesser-powered weapon, or a weapon where there is significant reloading time between shots, will cause unnecessary suffering to the animal and pose a risk to my safety.
29. Even assuming I could find suitable non-prohibited replacements for my rifles, it would take me a lot of time and effort to be able to find them and afford them. Buying the rifles would itself require travel far from home, as there is nowhere on Haida Gwaii, or even in Prince Rupert, where I can buy specialized hunting rifles.
30. I do work for money only occasionally, as there is little or no work of this kind for me on Haida Gwaii. However, it is a reality of life that work for money will be needed from time to time. The jobs I have experience with require significant and extended travel away from my home and my family, as far away as Manitoba. It was through these work stints that I

earned the money to purchase my rifles. Each of these purchases meant the sacrifice of extended time away from home.

31. In short, I believe there are no suitable, legal replacements for the Prohibited Rifles. Even if there were, I cannot easily afford to replace this specialized equipment. Without using the Prohibited Rifles, I will not be able to hunt in the same way, hunting the same game, in the same area. From my conversations with other Haida, I know this is true for many of them as well.

Learning about the Regulation; No consultation

32. I learned about the Regulation on the day it was announced by Prime Minister Trudeau. After I heard about it, I logged on to the government's website to check if any of my rifles were going to be prohibited, and learned that all four of the Prohibited Rifles were on the list.
33. I am not aware of any communications between the Haida people and the Federal Government about the Regulation, or about restricting or prohibiting of certain kinds of firearms specifically. If there had been any such communication, it would have been discussed in the Haida House of Assembly. There were no discussions like that. Based on that, I do not believe the Haida were consulted about any potential impacts that the Regulation might have on our ability to hunt and trap in the way we traditionally do, and the way in which we prefer.
34. I believe that there are a lot of Haida who are in a similar situation to me with their use of items that were prohibited under the Regulation. From my conversations with other Haida, the feeling is that this is another attempt by the government to roll back our rights and infringe on our way of life. We feel like the government is trying to tell us how to hunt, and what equipment to use, when this should be our decision.

Conclusion

35. If I am unable to use my Prohibited Items, this will hurt my ability to provide sustenance for myself, my family, and my community. I believe this is true for many other Haida people as well. It will also hurt my ability to do trapping and other wildlife management.

Those things impact my ability to live in the traditional way of the Haida. Hunting, trapping, and the use of those animals are all traditional ways of life for me and the Haida. These activities, and the way in which we prefer to go about them, connect me with the land, my family, my community, and my ancestors.

36. I swear this Affidavit in support of an Application for an injunction to stay the effect of the Regulation as a result of its infringement of my constitutionally-protected Aboriginal rights.

SWORN BEFORE ME at ~~the~~ *Prince Rupert,*
municipality of ~~Kitimat,~~ in the Province of
British Columbia, this *24th* day of
August, 2020.



A Notary Public in and for the Province of
British Columbia

Laurence Knowles



SUKHBIR K. JOHAL
Notary Public
PO Box 728, 222 5th Street
Prince Rupert BC V8J 3S4
T: 250 - 627 - 2328

This is **Exhibit "A"** referred to in the Affidavit of Laurence Knowles, sworn before me this 24th day of August, 2020.

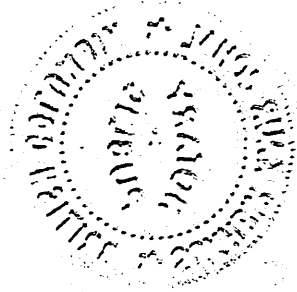

A Notary Public in and for the Province of
British Columbia

SUKHBIR K. JOHAL
Notary Public
PO Box 728, 222 5th Street
Prince Rupert BC V8J 3S4
T: 250 - 627 - 2328

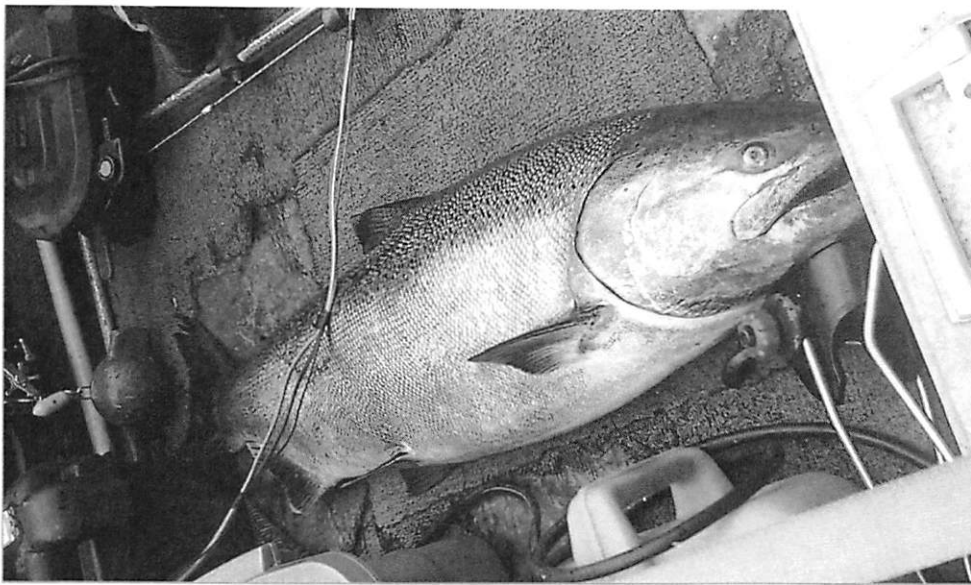

[Handwritten signature]

UNITED STATES DEPARTMENT OF JUSTICE
OFFICE OF INSPECTOR GENERAL
400 EAST 128th STREET
PRINCE GEORGE, MD 20782
TEL: 410-326-7300



Salmon closures announced for Skeena and Nass watersheds

DFO notice expands on May 21 chinook ban throughout Skeena watershed

QUINN BENDER / May. 27, 2020 1:30 p.m. / LOCAL NEWS / NEWS

The Department of Fisheries and Oceans has announced widespread closures to recreational salmon fishing affecting all fresh water areas of the North Coast.

The notice, effective May 27, includes a ban on chinook in all lakes and rivers flowing into management areas 3 to 6. The announcement expands on a May 19 notice prohibiting chinook angling throughout the Skeena Watershed.

In an email to Black Press Media a DFO spokesperson said the restrictions are in response to a Skeena Chinook return estimate of just 38,754. It was noted there will be no targeted commercial fisheries on Skeena Chinook this year, and that the final Area F Commercial troll fishery will be timed to avoid the species.

This is Exhibit "A" referred to in the Affidavit/ Statutory Declaration of Lawrence Howles Sworn (affirmed/declared) before me this 24 day of Aug, 2020

A Notary Public In and for the Province of British Columbia



SUKHBIR K. JOHAL
Notary Public
PO Box 728, 222 5th Street
Prince Rupert BC V8J 3S4
T: 250-627-2328

READ MORE: COVID-19 guidelines for recreational fishing expected this week

“Overall, expectations for salmon returns are generally low and similar to last year,” the spokesperson wrote. “A key factor is the relatively poor conditions for ocean survival for the sea entry and freshwater rearing years for salmon returning in 2020.”

Today’s notice also reduces the allowable catch of North Coast coho to two, excluding the Kitimat River.

Bans on all salmon species are also now in effect until further notice for sections of the Skeena mainstem near the Kitwanga and Kispiox Rivers. Future prohibitions are planned for July 1 to Aug. 31 near and within the Kitsumkalum River.

Recreational fishing for chum salmon remains closed throughout the Skeena and Nass River watersheds.

A draft of the Integrated Fisheries Management Plan forewarned low Chinook returns will call for conservation measures similar to 2018, which saw widespread closures on all species.

READ MORE: Eight Northwest salmon conservation projects receive funding for grassroots work

The DFO spokesperson blamed the low numbers primarily on environmental factors, adding that while fisheries plans will be adjusted throughout the season to account for actual returns, further closures are a possibility.

“Given the anticipated ongoing impacts of the extremely warm water temperatures in the central North East Pacific ocean starting in late 2013 and the resulting changes in the marine food web – zooplankton composition, density, and distribution, as well as the potential for drought conditions through the summer and fall (leading to lower than normal flows and higher than normal water temperatures), there will likely be requirements for additional management actions to ensure adequate numbers of certain stocks have the opportunity to migrate up-river and spawn.”



Get local stories you won't find anywhere else right to your inbox.

Sign up here

This is **Exhibit "B"** referred to in the Affidavit of Laurence Knowles, sworn before me this 24th day of August, 2020.



A Notary Public in and for the Province of
British Columbia

SUKHBIR K. JOHAL
Notary Public
PO Box 728, 222 5th Street
Prince Rupert BC V8J 3S4
T: 250 - 627 - 2328



Area A - Seine

Area A includes Areas 1 to 10, as defined in the Pacific Fishery Management Area Regulations.

Scale: 1:6 000 000

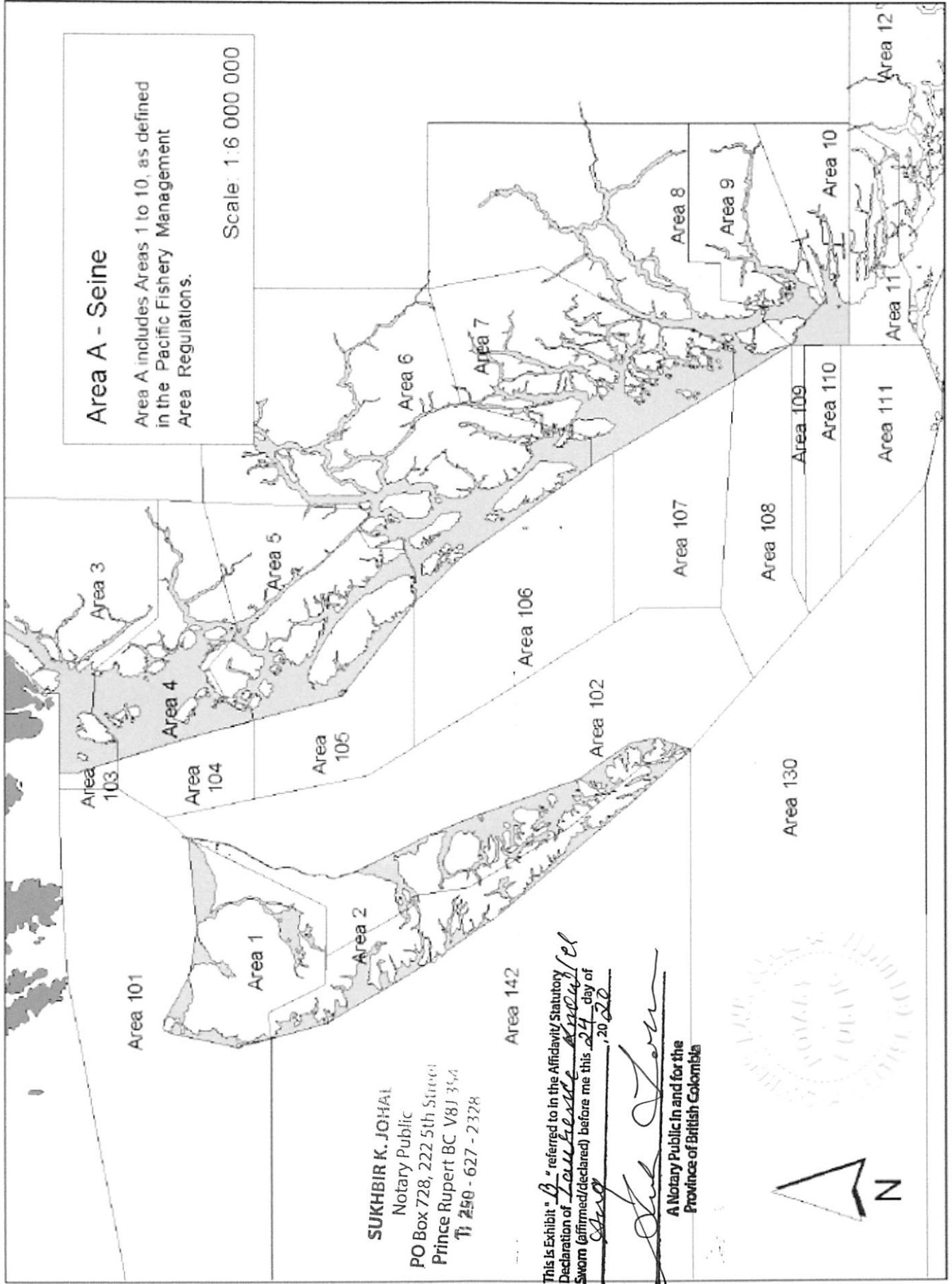

SUKHBIR K. JOHAL
Notary Public
PO Box 728, 222 5th Street
Prince Rupert BC V8J 3A4
T: 250 - 627 - 2328

Area 142

This is Exhibit "B" referred to in the Affidavit Statutory Declaration of Louise Ansel sworn (affirmed/declared) before me this 24 day of Aug, 2022

[Signature]

A Notary Public in and for the Province of British Columbia



This is **Exhibit "C"** referred to in the Affidavit of Laurence Knowles, sworn before me this 24th day of August, 2020.



A Notary Public in and for the Province of
British Columbia

SUKHBIR K. JOHAL
Notary Public
PO Box 728, 222 5th Street
Prince Rupert BC V8J 3S4
T: 250 - 627 - 2328



You are here: Home > Products > The Modern Rifle Series > Modern Varmint Constructor > Modern Varr

Modern Varmint Rifle

This is Exhibit "C" referred to in the Affidavit/ Statutory Declaration of Laurie Knowlton sworn (affirmed/declared) before me this 24 day of Aug, 2020

Suk Johal
 A Notary Public In and for the Province of British Columbia



SUKHBIR K. JOHAL
 Notary Public
 PO Box 728, 222 5th Street
 Prince Rupert BC V8J 3S4
 T: 250 - 827 - 2328

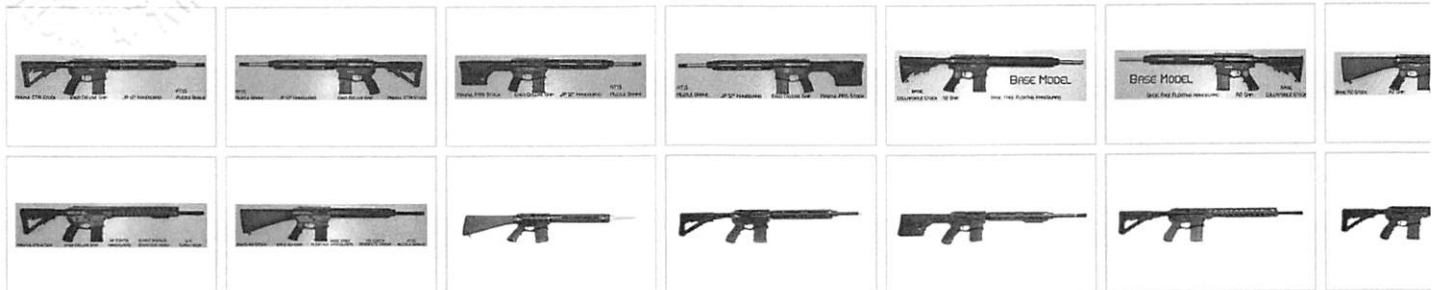

★★★★★
\$3,350.00

Choose options from dropdown list(s) below

Select your Caliber	.223 - 18.6" Long
Barrel specs	SS Light Contour - .625" ~ 1in8 Twist
Finish	Brushed SS Barrel
Brake / Flashhider	No Brake/Flashhider
Thread Protector	No Thread Protector
Handguard	DPMS HANDGUARD
Rail Sections	No Rail Sections
Grip	BASIC A2 (BLACK ONLY)
Stock	A2 FIXED STOCK (BLACK ONLY)
Ambi Safety	No Ambi Safety
Ambi Mag Release	No Ambi Mag Release
Cerakote	Factory Black Hard Anodize
Furniture Color	Black Furniture
Mags MV	One Mag

This item may be in stock but is not available for online ordering
 please call **403-277-7786** or **403-277-7266**
 or email info@albertatacticalrifle.com to purchase

CURRENTLY OUT OF STOCK AND NOT AVAILABLE FOR PRE-ORDER!

Production FRT has been issued

ATRS - MODERN VARMINT - FRT_162446 NON-RESTRICTED

Key features:

- NON RESTRICTED
- Integrated Ambi bolt release.
- Non reciprocating folding side-charge handle,
- sealed to prevent gas escape for the shooter.
- Ambi safety (optional)
- Ambi mag release (optional)
- 7075 billet upper and lower receivers,

- black MilSpec hard anodized.
- Hinged dust cover over ejection port.
- Left handed friendly shell deflector.
- Direct gas impingement operating system (tried and proven to work)
- Employs AR style grip and stock.
- Employs STANAG AR-15 mags.
- Match Grade Stainless steel barrel as standard.
- Timney Competition AR15 3lb trigger standard
- JP Silent Captured Spring System standard

Like all direct impingement operated rifles, this rifle works best with BTHP, polymer tip issues with lead tipped, all lead, round nose or other soft point bullets. It also requires gas This is critical for the first 500 rounds as the moving parts break in.

These rifles have a MATCH GRADE barrel and chamber. The use of off-shore surplus or any warranty . In our experience domestically manufactured bulk ammo will not harm with American Eagle 55gr FMJ bulk ammo.

As most know, the AR15 platform is a restricted rifle in Canada. We have come up with in so far as being very modular and it will accept the use of most AR15 furniture, but it i

The base model rifle is \$3350.00 and includes, among other things, a match grade stair trigger, and a JP silent captured spring system! A large number of upgrades are available The base model rifle has the option of either an A2 fixed stock or a 6 position collapsible collapsible, Magpul PRS adjustable and KFS TacMod adjustable stock.

Barrels chambered in 223 Wylde are only available in an 18.6" length. Barrels chambered All barrels will come standard with a threaded muzzle.

Stainless barrels will be available in 3 contours, light, medium and heavy.

We also offer an optional Proof Research Carbon Fiber Wrapped barrel or BSF carbon f

Ambi bolt release comes standard on the base model and ambi safety and mag release a The base model rifle will be offered with a free float tube style handguard, however Mag modular handguards, Fortis Mfg. SWITCH Keymod handguards and PRI carbon fiber h

*-Proof Research barrel weight:
18.6"- 2.1 lbs*

*-Stainless Steel barrel weights:
18.6" light contour- 2.1 lbs
18.6" varmint contour- 3.3 lbs
18.6" heavy contour- 4.5 lbs*

Please note:

- All special orders and custom rifle builds are not returnable and a
- Dimensions, and specifications are subject to change without price
- Modern Varmint Rifles are sold only as complete rifles.
- Delivery times are estimates and do not imply in anyway a guarantee in months.
- This rifle does not come with sights/optics or a case however either

Below are diagrams of the 3 stainless barrel contours available:

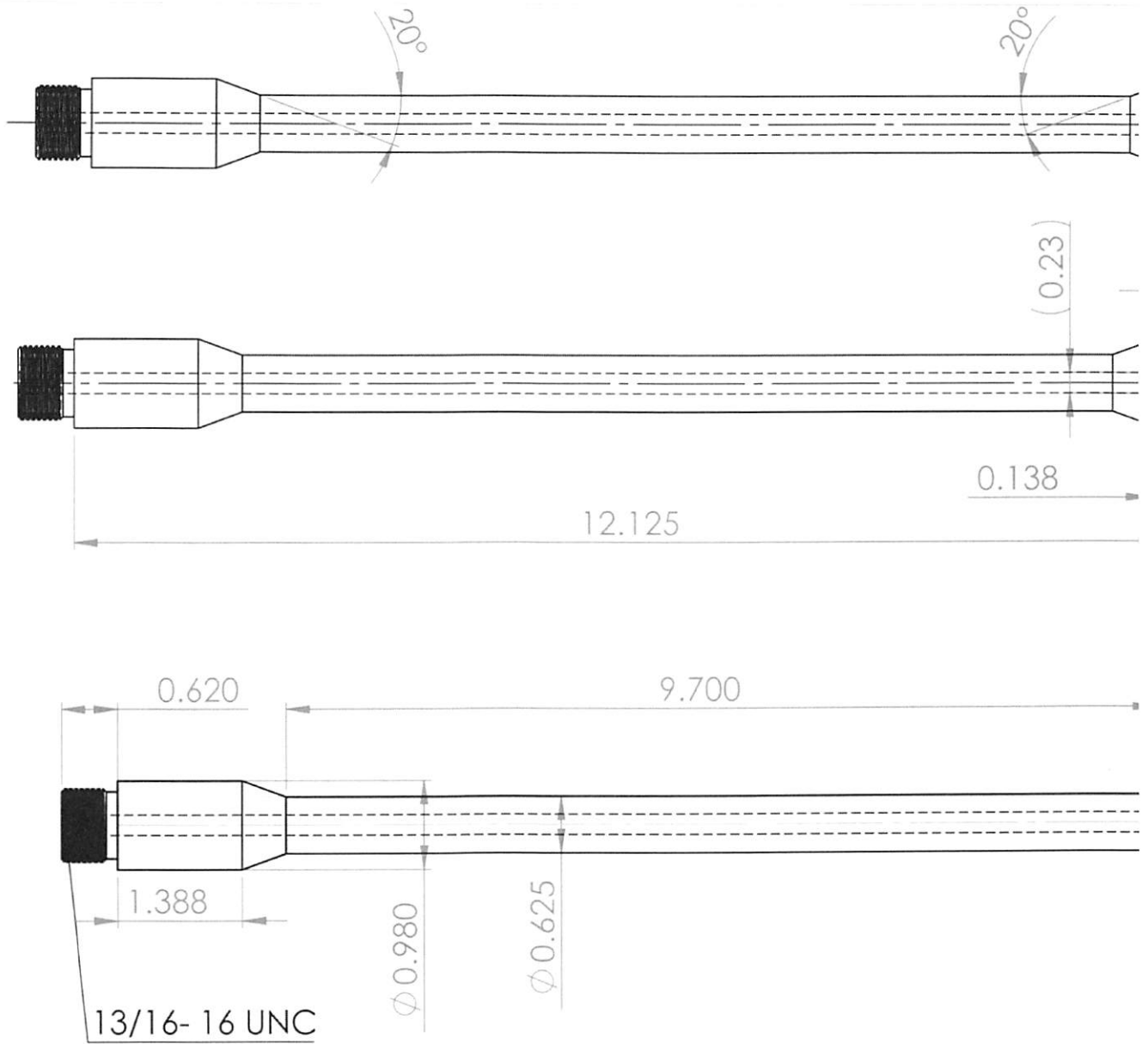

PROPRIETARY AND CONFIDENTIAL
 THE INFORMATION CONTAINED IN THIS
 DRAWING IS THE SOLE PROPERTY OF
 MAGNUM MACHINE LTD. ANY
 REPRODUCTION IN PART OR AS A WHOLE
 WITHOUT THE WRITTEN PERMISSION OF
 MAGNUM MACHINE LTD IS
 PROHIBITED.

		UNLESS OTHERWISE SPECIFIED:	
		DIMENSIONS ARE IN INCHES	DRAWN
		TOLERANCES:	CHECKED
		FRACTIONAL ±1/16	ENG APPR.
		ANGULAR: MACH ± 1 deg	MFG APPR.
		TWO PLACE DECIMAL ±0.01	
		THREE PLACE DECIMAL ±0.005	
		INTERPRET GEOMETRIC TOLERANCING PER:	Q.A.
		MATERIAL	COMMENTS:
NEXT ASSY	USED ON	FINISH 3.2	
APPLICATION		DO NOT SCALE DRAWING	

5

4

3

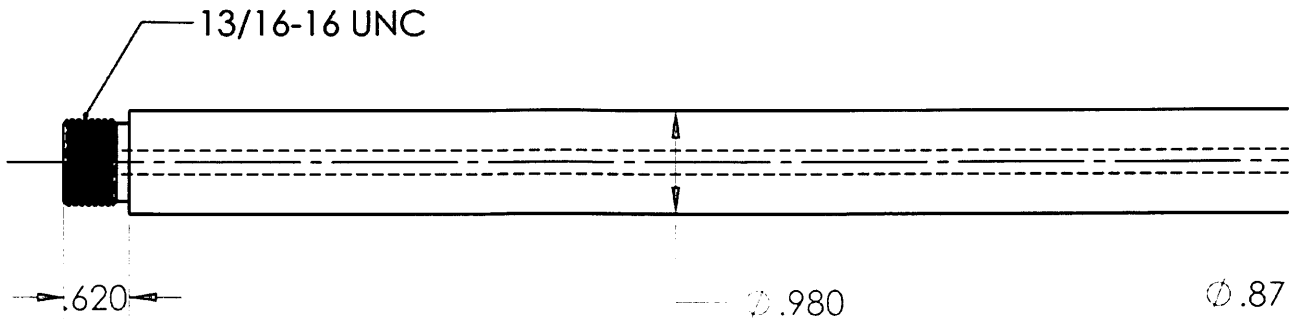
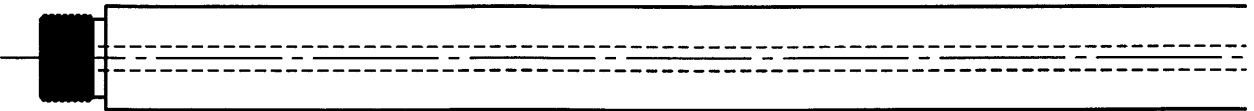
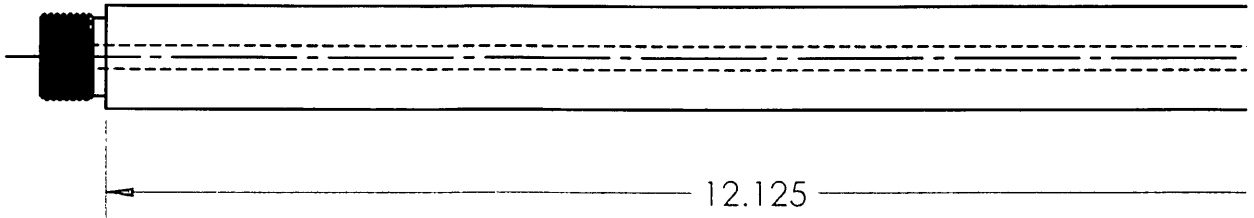

UNLESS OTHERWISE SPECIFIED:

DIMENSIONS ARE IN INCHES	DRAWN
TOLERANCES:	CHECKED
FRACTIONAL $\pm 1/16$	ENG APPR.
ANGULAR: MACH ± 1 deg	MFG APPR.
TWO PLACE DECIMAL ± 0.01	
THREE PLACE DECIMAL ± 0.005	

INTERPRET GEOMETRIC TOLERANCING PER:	Q.A.
MATERIAL	COMMENTS:

PROPRIETARY AND CONFIDENTIAL
 THE INFORMATION CONTAINED IN THIS
 DRAWING IS THE SOLE PROPERTY OF
 MAGNUM MACHINE LTD. ANY
 REPRODUCTION IN PART OR AS A WHOLE
 WITHOUT THE WRITTEN PERMISSION OF
 MAGNUM MACHINE LTD IS
 PROHIBITED.

NEXT ASSY USED ON
 APPLICATION

FINISH $\sqrt{3.2}$
 DO NOT SCALE DRAWING

5

4

3

Links to accessories:

(Click on words to open a new page with info)

DPMS free float handguard

JP Enterprise Modular handguard

JP Enterprise 2" rail section

JP Enterprise 4" rail section

JP Enterprise top rail

Fortis Mfg. SWITCH Keymod handguard

Fortis Mfg. Keymod accessories

PRI Carbon Fiber handguard (black)

PRI Carbon Fiber handguard (natural)

BLK LBL™ (Integrated Bipod)

KFS TacMod Stock

Magpul PRS stock

Magpul CTR stock

Magpul MOE grip

Magpul MIAD grip

Ergo Suregrip

Ergo Deluxe grip

ATRS At-15 Muzzle Brake

ATRS AT-15 LFE(Light-weight Flash Eliminator)

Proof Research Carbon Fiber Wrapped barrels

Downloads

Modern Varmint FRT

Related products



\$60.00

AR-15 Bolt Component Kit



Temporarily out of stock

Notify me when available



\$40.00

DPMS AR-15 Pin Kit



Temporarily out of stock

Notify me when available



\$25.00

DPMS AR-15 Spring Kit



Temporarily out of stock

Notify me when available

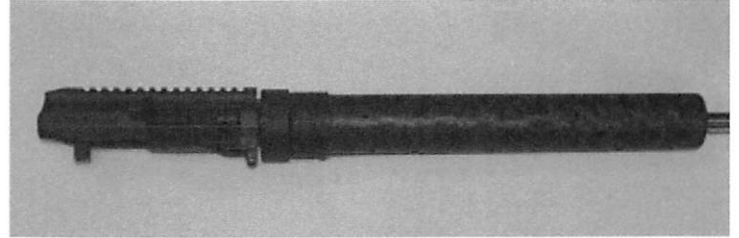

\$1,700.00

Modern Varmint Complete Upper Receiver



This item may be in stock but is not available for online ordering please call 403-277-7786 or 403-277-726

Display #

Results 1 - 4 of 4

Please login to post comments

Featured products (Click on images for more information)



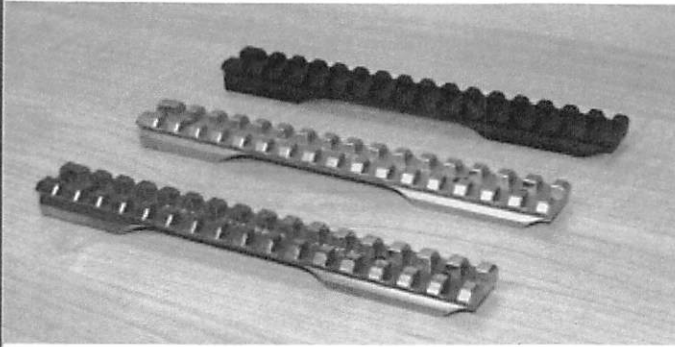

\$165.00

ATBC 4012 Distinctive Rails

Featured Products

New !!! < > Limited one time specials

Contact us

E-mail: info@albertatacticalrifle.com

#6-2016 25th Ave NE [For MAP Click HERE](#)

Phone: 403-277-7786 and 403-277-7266

Calgary, AB

Designed by www.RemotelyYours.com

This is **Exhibit "D"** referred to in the Affidavit of Laurence Knowles, sworn before me this 24th day of August, 2020.

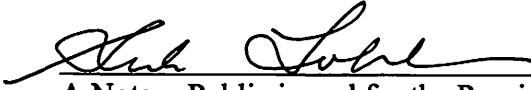

A Notary Public in and for the Province of
British Columbia

SUKHBIR K. JOHAL
Notary Public
PO Box 728, 222 5th Street
Prince Rupert BC V8J 3S4
T: 250 - 627 - 2328



You are here: Home (../home) / Product Detail

This is Exhibit "D" referred to in the Affidavit/Statutory Declaration of Laurence Ansel Sworn (affirmed/declared) before me this 24 day of August, 2020

Shirley Lou
A Notary Public In and for the Province of British Columbia



SUKHBIR K. JOHAL
Notary Public
PO Box 728, 222 5th Street
Prince Rupert BC V8J 3S4
T: 250 - 627 - 2328



(/images/items/Fullsize/STGSTAG580047.jpg?t=636737265091316270) (+) (/images/items/Fullsize/STGSTAG580047.jpg)



(/images/items/Fullsize/STGSTAG580047.jpg) (/images/items/Fullsize/STGSTAG580047-2.jpg)

\$1,795.00

Product Code:
STGSTAG580047

Availability: Out of Stock

Stag Arms Stag-10 Bones Rifle .308 Win 18.6" - No Furniture Black

Overview

The Stag 10 .308 Bones Rifle is a high quality, durable, large frame AR rifle that is ready for you to customize to your liking.



This model features a .308 chamber 18" 1/10 barrel, 6 position receiver extension tube, and a QPQ Nitride coated BCG.

Every complete rifle from Stag Arms comes with a Transferable Lifetime Warranty, an Infinite Shot Barrel Guarantee, a magazine and a rifle case.

Specifications

Model: Stag 10 Bones - STAG580047

Calibre: .308 Win.

Action: Semi-Auto

Safety Type: Two-Position

Trigger Type: Mil-spec single stage trigger with a non-adjustable 5-8 lb trigger pull

Barrel Specifications: 10.6" 4150 steel, chrome lined

Twist Rate: 1:10" button rifled

Gas System: Low Profile Gas Block with Rifle Length Gas Tube

Muzzle Device: A2 Flash Hider

Upper Receiver: Forged 7075 T6 aluminum with type 3 hard coat anodizing. Upper features a .210 Tang Height (DPMS High Profile)

Lower Receiver: Forged 7075 T6 aluminum with type 3 hard coat anodizing

Furniture: None/6 position receiver extension tube

Handguard: N/A

Sights: Sold Separately

Finish: Black

Capacity: 5 Rounds - Comes with GI Mag

Weight: TBD

Overall Length: TBD

Condition: New

Classification: Non-Restricted

Features:

Action: Semi-Auto Direct Impingement

Bolt Carrier: .308 Nitride QPQ BCG

Hammer/Trigger pin size: Mil-spec small pin .154"

Pivot/Takedown Pin Size: .2770"

Buffer: Standard .308 Carbine Buffer and .308 Action Spring

Pricing and specifications subject to change without notice. Product photos may not always be exactly as shown. Manufacturer's specifications are subject to change, and sometimes without prior notice.

Average Rating

This product is not rated.

RELATED PRODUCTS

CUSTOMERS WHO PURCHASED THIS PRODUCT ALSO BOUGHT...

PRODUCT DOCUMENTATION

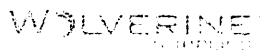

© Wolverine Supplies 2020

TCC Financing

(<http://www.tacticalcapitalcorp.com/>) | [Privacy Policy \(/wolverine-experience/privacy-policy\)](#) | [Conditions of Use \(/wolverine-experience/conditions-of-use\)](#)

 (<http://facebook.com/WolverineSupplies>)  (http://twitter.com/wolv_supplies) 
(http://instagram.com/wolv_supplies/)  (<http://youtube.com/user/WolverineSupplies89>)

PHOTOCOPY CERTIFIED TRUE

Photostat of this IDS
consists of 1 page/s, dated at the City of
Prince Rupert in the Province of British Columbia
this 24 day of Aug 2020



Sukhbir K. Johal

A Notary Public in and for the Province of British Columbia

This is a photocopy of an original document
that does not appear to be altered

SUKHBIR K. JOHAL

Notary Public

PO Box 728, 222 5th Street

Prince Rupert BC V8J 3S4

T: 250 - 627 - 2328