

FEDERAL COURT

BETWEEN:

CANADIAN COALITION FOR FIREARM RIGHTS, RODNEY GILTACA,
LAURENCE KNOWLES, RYAN STEACY, MACCABEE DEFENSE INC.,
WOLVERINE SUPPLIES LTD., AND MAGNUM MACHINE LTD.

Applicants

and

ATTORNEY GENERAL OF CANADA and CANADA (ROYAL CANADIAN
MOUNTED POLICE)

Respondents

APPLICATION UNDER sections 18 and 18.1 of the *Federal Courts Act*, RSC 1985, c F-7.

AFFIDAVIT

I, Rick Timmins, of the City of Calgary, in the Province of Alberta, SWEAR THAT:

1. I am an Applicant to the Application in Court File No T-577-20 (the “**Application**”). I am the founder and owner of Alberta Tactical Rifle Supply (“**ATRS**”). I have personal knowledge of the facts sworn to in this Affidavit, except where I have stated facts that are based on information I have received, and in those cases I believe the information to be true.
2. The Application is a judicial review application and Charter challenge of the *Regulations Amending the Regulations Prescribing Certain Firearms and Other Weapons, Components and Parts of Weapons, Accessories, Cartridge Magazines, Ammunition and Projectiles as Prohibited, Restricted or Non-Restricted*, SOR/2020-96 (the “**Regulation**”) and the *Order Declaring an Amnesty Period (2020)*, SOR/2020-97 (the “**Amnesty Order**”). The Application is also a judicial review application of certain ad hoc things done by the Royal Canadian Mounted Police (“**RCMP**”), including through the Specialized Firearms Supports Services Unit (“**SFSS**”) and the Firearms Reference Table (“**FRT**”), as described in the Application. I adopt the defined terms in that Application for the purposes of this my Affidavit.

3. ATRS was incorporated in 2009 as Magnum Machine Ltd. (doing business as ATRS). I started ATRS in or about 1997 out of my home as a retirement project.

4. By the early 2000's, ATRS was doing gunsmithing work and supplying specialty firearms parts and optics for the Calgary Police Tactical Unit and the Edmonton Police Tactical Unit.

5. In 2008, ATRS began manufacturing its own version of the AR-15 rifle, known as the AT-15. The AT-15 is a direct descendant of the AR-15 rifle invented by the famous firearms designer Eugene Stoner in the 1950's and was classified as a 'restricted' firearm prior to becoming prohibited on May 1, 2020, when the federal government passed the Regulation. Because of its status as a 'restricted' firearm, the AT-15 could not be used for hunting purpose and could only be used for target shooting in accordance with Canadian firearms laws.

Design of the ATRS Modern Hunter

6. In or about the fall of 2011, I started the process of designing a new semi-automatic rifle that would eventually be called the Modern Hunter ("**Modern Hunter**"). That rifle was designed from the ground up to be a hunting and sporting firearm. It was not designed for military combat or law enforcement use. My goal was to design a rifle that would fit the parameters of a 'non-restricted' firearm pursuant to Canadian law, while utilizing modular design and modern materials.

7. The Modern Hunter was designed to meet the following technical criteria:
- a. to utilize proprietary upper and lower receivers that are not compatible with any other rifle currently available, so that the Modern Hunter could not be considered a derivative of any other firearm;
 - b. to not be easily convertible into a fully-automatic or select-fire firearm;
 - c. to fit the parameters of a 'non-restricted' firearm as defined in the *Criminal Code*, RSC 1985, c C-46;

- d. to be as compact as possible, while maintaining the overall length (“OAL”) of at least 660 mm and barrel length of at least 470 mm as prescribed by the *Criminal Code* for ‘non-restricted’ firearms; and
- e. to have the modularity and adaptability to fit human bodies of all shapes and sizes.

8. ATRS went to great pains to ensure that the Modern Hunter was a unique design and could not be considered a derivative of any existing firearm. It was especially important for ATRS to design a rifle that was not a derivative of the AR-15, as the AR-15 was classified as a restricted firearm at the time and could not be used for hunting.

9. To achieve that goal, both the upper and lower receivers of the Modern Hunter were designed with distinct geometries so that they could not be fitted to any existing rifle. A number of other components utilized in the Modern Hunter were also designed to be completely proprietary and not interchangeable with other firearms, including the following:

- a. bolt components, including the bolt body, charge handle and bolt release;
- b. safety detents and springs installed in the lower receiver;
- c. buffer retention system; and
- d. barrel extension (which precludes the use of any barrel not specifically designed for the Modern Hunter).

10. To ensure that the Modern Hunter could not be easily converted into a fully-automatic or select-fire firearm, it was designed to have a ‘high shelf’ style lower receiver, a trigger retention system that allows for the use of just one proprietary trigger pack, manufactured by Timney Triggers LLC. Consequently, no other fire control group can be retrofitted to the Modern Hunter without extensive modification by an expert machinist using highly specialized tools. In addition, the upper receiver of the Modern Hunter does not have the cut-out for the secondary timing sear as found in select-fire military rifles.

11. The Modern Hunter was also designed to exceed minimum OAL and barrel length requirements for non-restricted firearms. To do that, ATRS utilized a proprietary barrel that is 18.6 inches in length.

12. The overall tolerances of the Modern Hunter are much tighter than those found in military firearms. This was done to enhance accuracy, which is obviously important for sport shooting and hunting, but at the cost of not being able to tolerate mud and debris that a military rifle would have to tolerate. Given the fact that ATRS did not design the Modern Hunter for military or law enforcement applications, this shortcoming was not a concern.

Original classification of the Modern Hunter

13. In or about the spring of 2012, the first prototype of the Modern Hunter was submitted to the SFSS for a determination of its legal classification. The SFSS is a division of the RCMP that provides support to federal, provincial and municipal police, specialized guns and gangs units, as well as government agencies such as the Canadian Border Services Agency.

14. The SFSS has created and continues to maintain and update a computer database known as the FRT, which is a list of firearm descriptions and classifications that is accessible by law enforcement and authorized users. There is a separate published FRT that is available to the public, but it is not current and it is very long and difficult to navigate.

15. During the process of submitting the prototype of the Modern Hunter to the SFSS, ATRS was dealing with William Etter (“**Mr. Etter**”), Chief Firearms Technologist with the SFSS. After numerous delays, ATRS finally received confirmation on May 8, 2014 that the prototype submitted to the SFSS was determined to be a non-restricted firearm.

16. Shortly thereafter, ATRS submitted the final production version of the Modern Rifle to the SFSS. The production version was likewise determined to be a non-restricted firearm. On January 20, 2015, a new entry was added to the FRT categorizing the Modern Hunter as a non-restricted firearm.

17. Attached as **Exhibit “A”** to my Affidavit is a copy of the January 20, 2015 FRT report describing the Modern Hunter in .308 Winchester as a non-restricted firearm.

18. The Modern Hunter was initially introduced in the .308 Winchester caliber and was subsequently produced in several other popular hunting calibers, namely .243 Winchester, .260 Remington, 6.5 Creedmoor, 7MM-08, and .338 Federal. A longer-barrel version of the .308 Winchester rifle was also produced. All of these firearms were categorized as 'non-restricted' by the SFSS.

19. Attached as **Exhibit "B"** to my Affidavit is a copy of the July 19, 2017 FRT report showing all versions of the Modern Hunter as non-restricted firearms.

20. ATRS also received a complete FRT inspection report dated January 8, 2015 signed by Mr. Etter. In his inspection report, Mr. Etter concluded that the Modern Hunter's "design is derived from an amalgamation of several different firearm designs and does not trace its design lineage directly or uniquely to a 'prohibited' or a 'restricted' firearm found in the Regulations appended to the Criminal Code."

21. Attached as **Exhibit "C"** to my Affidavit is a copy of Mr. Etter's January 8, 2015 inspection report in connection with the Modern Hunter.

22. On March 30, 2015, I attended a meeting with the then-Minister of Public Safety and Emergency Preparedness, Stephen Blaney ("**Mr. Blaney**"), during which I voiced my concerns about the length of time it took to receive an opinion from the SFSS regarding the legal status of a new firearm. During the meeting, Mr. Blaney told me that the FRT did not determine the legal status of a firearm and that it was simply a reference tool. I was further told that getting an FRT report from the SFSS was not a legal prerequisite for introducing a new type of firearm to the Canadian market. This fact is also published in the FRT. Attached as **Exhibit "D"** to my Affidavit is a copy of the FRT where this is stated.

23. I was stunned by this revelation, as it was always my understanding that in order to be sold in Canada, a firearm must have an FRT report. In any event, selling a new type of firearm before the RCMP has issued an FRT report seemed like an extremely risky course of action. Until my conversation with Mr. Blaney, I had understood that if the RCMP later determines that the firearm in question is a prohibited firearm and updates the FRT accordingly, the buyer and seller of such a firearm could potentially be charged with criminal offences.

Modern Varmint

24. In or about 2015, ATRS scaled down the Modern Hunter to create the Modern Varmint rifle (“**Modern Varmint**”), which is identical except in terms of size and the calibers offered. The Modern Varmint was built to accept 5.56 mm cartridges. It was submitted for inspection to the SFSS and, on November 23, 2015, the SFSS added a new entry to the FRT categorizing the Modern Varmint as a non-restricted firearm.

25. In addition to 5.56 mm, the Modern Varmint was later produced in the 6.5 mm Grendel caliber. A rifle chambered in that caliber was also submitted to the SFSS and determined to be a non-restricted firearm.

26. Attached as **Exhibit “E”** to my Affidavit is a copy of the July 19, 2017 FRT report showing all versions of the Modern Varmint as non-restricted firearms.

Modern Sporter

27. In or about 2017, ATRS made some changes to the Modern Varmint to reduce manufacturing costs and to allow for increased customization by the end user. The end result was a rifle called the Modern Sporter rifle (“**Modern Sporter**”). The additional ability for end user customization was a result of requests made of ATRS by many competitive target shooters. For example, the end user could customize the Modern Sporter by employing an assortment of different charge handles, trigger assemblies, stocks, grips and fore ends that are available from a number of different manufacturers.

28. The SFSS inspected the Modern Sporter and, on October 4, 2018, added a new entry to the FRT categorizing the Modern Sporter as a non-restricted firearm.

29. Attached as **Exhibit “F”** to my Affidavit is a copy of the October 4, 2018 FRT report classifying the Modern Sporter as a non-restricted firearm.

30. ATRS also received a complete FRT inspection report in connection with the Modern Sporter, dated October 10, 2018 signed by Mr. Etter. In his report, Mr. Etter concludes that, as in the case of the Modern Hunter, the Modern Sporter’s “design is derived from an amalgamation of several different firearm designs and does not trace its design lineage

directly or uniquely to a ‘prohibited’ or a ‘restricted’ firearm found in the Regulations appended to the Criminal Code.”

31. Attached as **Exhibit “G”** to my Affidavit is a copy of Mr. Etter’s October 4, 2018 inspection report in connection with the Modern Sporter.

Classification Changes

32. On May 1, 2020, the federal government introduced the Regulation and prohibited approximately 1,500 firearms that were previously classified as restricted or non-restricted. The ATRS firearms that are specifically named in the Regulation are AT-15, which is banned as an AR-15 variant; the ATSHL lower which was made to mate up with a modified DA50 50 caliber bolt action upper; and the ATRS Big Bertha which is a 50 caliber single shot bolt action rifle.

33. The prefix “AT” is ordinarily a reference to Alberta Tactical. Listed in the Regulation is “AT-50”. While this appears to be a reference to a product manufactured by ATRS, it appears to be an error because there is no firearm named “AT-50” manufactured or in production. The AT-50 was merely a concept but never put into production.

34. The Modern Hunter, Modern Varmint and Modern Sporter (collectively “**Modern Rifles**”) are not listed or otherwise enumerated in the Regulation.

35. Nevertheless, at some point after May 1, 2020, SFSS started to modify the FRT by changing the classification of the Modern Rifles from non-restricted to prohibited and has made changes to the FRT reports by removing or redacting notes that were previously available.

36. Attached as **Exhibit “H”** to my Affidavit is a copy of the FRT Report dated May 15, 2020 which purports to re-classify the Modern Hunter from a non-restricted firearm to a prohibited firearm.

37. Attached as **Exhibit “I”** to my Affidavit is a copy of the FRT Report dated May 15, 2020 which purports to re-classify the Modern Varmint from a non-restricted firearm to a prohibited firearm.

38. Attached as **Exhibit “J”** to my Affidavit is a copy of the FRT Report dated June 11, 2020 which purports to re-classify the Modern Sporter from a non-restricted firearm to a prohibited firearm.

39. Each of the these FRT reports made after May 1, 2020 (collectively the “**Revised FRT Reports**”), under the heading ‘Legal Classification’, describe the firearm in question as prohibited pursuant to Part 1, Paragraph 87 of the newly-amended SOR/98-462. That paragraph states that firearms of the “designs commonly known as the M16, AR-10 and AR-15 rifles and the M4 carbine, and any variants or modified versions of them” are now prohibited firearms.

40. This ‘legal classification’ contained in the Revised FRT Reports is contrary to the comments contained in the earlier FRT reports attached as Exhibits A, B, E and F to my Affidavit (“**Original FRT Reports**”). Each of the Original FRT Reports has a section named ‘Canadian Law Comments’ which states that “this firearm design is derived from an amalgamation of several different firearm designs and does not trace its design lineage directly or uniquely to a ‘prohibited’ or a ‘restricted’ firearm found in the Regulations appended to the Criminal Code.” This section is missing from the Revised FRT Reports. The M16 rifle has been prohibited for over 40 years due to the select fire capability. The AR-15, M4 and AR-10 rifles were, until May 1, 2020, classified as restricted rifles and had been in that category for over 20 years at the time ATRS’ Modern series of rifles were given non-restricted legal classification by the SSFS in the FRT.

41. The Original FRT Reports are no longer accessible through the FRT, as the FRT does not provide ‘point-in-time’ reports. The only reason why I still have them is because I previously archived those reports. A member of the public or a law enforcement officer accessing the FRT today would no longer be able to see the Original FRT Reports.

42. In these ways, the SFSS has suddenly and radically changed its assessment of the Modern Rifles. It went from classifying them as non-restricted firearms that do not trace their lineage to any restricted or prohibited firearm to categorizing them as variants of the AR-10/AR-15/M16/M4 family of rifles. I have not been provided with any explanation for this irreconcilable change in logic. There have been no design or specification changes to the

Modern Rifles since they were inspected by the SFSS in 2015 and 2018. The SFSS did not re-inspect those firearms or consult with ATRS before posting the Revised FRT Reports.

Impact on the ATRS

43. ATRS is a small business based in Calgary, Alberta. Prior to May 1, 2020, ATRS had 10 employees. Since then, we have had to lay off two employees because of the Regulation and I am afraid that more people will have to be let go.

44. ATRS' business has been negatively impacted by the changes to the FRT. Not only have sales of ATRS Modern series rifles dropped significantly, ATRS is now unable to sell some of its existing proprietary designs. It is also not in a position to viably or economically design and market any new firearms, as they too could be classified as variants of prohibited firearms for arbitrary reasons. After all, the Modern Rifles were specifically designed not to be variants of any existing prohibited or restricted firearms and were initially determined to be non-restricted by the SFSS.

SWORN BEFORE ME at the City of
Calgary, in the Province of Alberta, this
10 day of September, 2020.



A Commissioner for Oaths in and for the
Province of Alberta

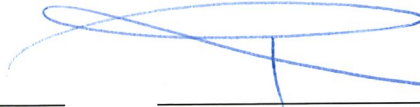

Rick Timmins

This is **Exhibit "A"** referred to in the Affidavit of Rick Timmins, sworn before me this 10
day of September, 2020.



A Commissioner for Oaths in and for the
Province of Alberta



Summary

Make: Alberta Tactical Rifle
Model: Modern Hunter
Manufacturer: Alberta Tactical Rifle
Level: Manufacturer Specifications and Commercial Customization
Type: Rifle
Action: Semi-Automatic
Country of Manufacturer: CANADA
Serial Numbering: See Note
Legal Classification: Non-Restricted

Calibre, Shots and Barrel Length

Firearm Ref. No.	Calibre	Shots	Barrel (mm)	Legal Classification	Level	Barrel Type Code
149826 - 1	308 WIN	5	560	Non-Restricted CC 2 "Firearm"	Manufacturer Specifications and Commercial Customization	

Notes

Make "ALBERTA TACTICAL RIFLE" "MODEL Modern Hunter" "S/N. # ATRS14-MH-PROT03" "CALGARY, ALBERTA", "outline of a Maple leaf" and "CANADA" was observed marked on the right side of the magazine housing of the receiver/frame.

Model

- introduced in 2015.
- this firearm is a production version of the ATRS, Model, Modern Hunter firearm.
- the ATRS Modern Hunter uses a Timney AR-10 self-contained drop in trigger unit with single hammer pin mounting system.
- the trigger well in the lower receiver is machined to fit mil-spec AR-10, 15 trigger and hammer parts, however this particular firearm receiver has a self-contained trigger mechanism which mounts on the hammer axis pin, there is no trigger pin hole in the receiver.
- the ATRS, Model - Modern Hunter upper receiver does not have a cut for an automatic sear, and has a different system for mounting upper to lower receivers than either the AR-10 or AR-15 Rifles.
- overall length of firearm butt collapsed 980mm.
- overall length of firearm butt extended 1080mm.

Manufacturer

- Alberta Tactical Rifle/Alberta Tactical Rifle Supply is located in Calgary, Alberta, Canada.
- Alberta Tactical Rifle/Alberta Tactical Rifle Supply is a Division of Magnum Machine Limited.
- Alberta Tactical Rifle/Alberta Tactical Rifle Supply specializes in custom precision rifle manufacture, upgrades and modifications.

Action - gas operated.

Calibre - 308 WIN 1:10 and "ATRS" may be found marked on the barrel.



FRT Report

Network Version 3.18.0

Firearm Reference No.: 149826

Date: 2015/01/20
Page: 2 / 3

Shots

- detachable box magazine.
- the magazine well of the ATR Modern Hunter is of an early (first generation) AR-10 design, and will accept early AR-10 magazines and the Stoner SR-25 magazine.
- late model AR-10 magazines do not fit and function in this firearm.

Serial Number

- serial number rationalization as follows: - the ATRS prefix is an abbreviation of the manufacturer's brand name, Alberta Tactical Rifle Supply; followed by 2 digits - indicating the year of manufacture, followed by the Roman alphabet letters "MH" denoting the model - "Modern Hunter"; with the final six (6) sequential digits being the firearm's unique serial number within the Modern Hunter series production.
- serial number was observed marked on the right side of the magazine housing of the lower receiver/frame.
- observed serial number consisted of a four letter prefix followed by a series of letters and numbers.

Canadian Law

- as received at Specialized Firearms Support Services Section, the Make - Alberta Tactical Rifle, Model - Modern Hunter, serial number ATRS14-MH-PROT03 contains the receiver / frame of a semi-automatic firearm. Further, this firearm design is derived from an amalgamation of several different firearm designs and does not trace its design lineage directly or uniquely to a "prohibited" or a "restricted" firearm found in the Regulations appended to the Criminal Code.

Comments

Other Markings

- the trade name "Alberta Tactical Rifle" may be found marked upon the left side of the upper receiver.
- a stylized maple leaf and the word CANADA may be found marked on the right side of the upper receiver to the rear of the ejection opening.

Cross-References

Firearm Ref. No. Make	Model	Manufacturer	Type	Action
146190	Modern Hunter Prototype	Alberta Tactical Rifle	Rifle	Semi-Automatic

Alberta Tactical Rifle

Alberta Tactical Rifle

Also Known As/Product Code

ATRS MH

MH

Year Dates

No Data Retrieved

Importer

No Data Retrieved



FRT Report
Network Version 3.18.0

Firearm Reference No.: 149826

Date: 2015/01/20
Page: 3 / 3

This is **Exhibit "B"** referred to in the Affidavit of Rick Timmins, sworn before me this 10
day of September, 2020.



A Commissioner for Oaths in and for the
Province of Alberta



Summary

Make: Alberta Tactical Rifle
Model: Modern Hunter
Manufacturer: Alberta Tactical Rifle
Level: Manufacturer Specifications and Commercial Customization
Type: Rifle
Action: Semi-Automatic
Country of Manufacturer: CANADA
Serial Numbering: See Note
Legal Classification: Non-Restricted

Calibre, Shots and Barrel Length

Firearm Ref. No.	Calibre	Shots	Barrel (mm)	Legal Classification	Level	Barrel Type Code
149826 - 2	243 W/IN	5	473	Non-Restricted CC 2 "firearm"	Manufacturer Specifications and Commercial Customization	
149826 - 3	260 REM	5	473	Non-Restricted CC 2 "firearm"	Manufacturer Specifications and Commercial Customization	
149826 - 4	308 W/IN	5	473	Non-Restricted CC 2 "firearm"	Manufacturer Specifications and Commercial Customization	
149826 - 1	308 W/IN	5	560	Non-Restricted CC 2 "firearm"	Manufacturer Specifications and Commercial Customization	
149826 - 5	338 FEDERAL	5	473	Non-Restricted CC 2 "firearm"	Manufacturer Specifications and Commercial Customization	
149826 - 6	6.5MM CREEDMOOR	5	473	Non-Restricted CC 2 "firearm"	Manufacturer Specifications and Commercial Customization	
149826 - 7	7MM-08 REM	5	473	Non-Restricted CC 2 "firearm"	Manufacturer Specifications and Commercial Customization	

Notes

Make - "ALBERTA TACTICAL RIFLE", "MODEL Modern Hunter", "CALGARY, ALBERTA", "outline of a Maple leaf" and "CANADA" was observed marked on the right side of the magazine housing of the receiver/frame.



FRT Report

Network Version 3.18.0

Firearm Reference No.: 149826

Date: 2017/07/19
Page: 2 / 13

Model

- introduced in 2015.
- this firearm is a production version of the ATRS, Model, Modern Hunter firearm.
- the ATRS Modern Hunter uses a Timney AR-10 self-contained drop in trigger unit with single hammer pin mounting system.
- the trigger well in the lower receiver is machined to fit mil-spec AR-10, 15 trigger and hammer parts; however this particular firearm receiver has a self-contained trigger mechanism which mounts on the hammer axis pin, there is no trigger pin hole in the receiver.
- the ATRS, Model - Modern Hunter upper receiver does not have a cut for an automatic sear, and has a different system for mounting upper to lower receivers than either the AR-10 or AR-15 Rifles.
- overall length of firearm butt collapsed 980mm.
- overall length of firearm butt extended 1080mm.

Manufacturer

- Alberta Tactical Rifle/Alberta Tactical Rifle Supply is located in Calgary, Alberta, Canada.
- Alberta Tactical Rifle/Alberta Tactical Rifle Supply is a Division of Magnum Machine Limited.
- Alberta Tactical Rifle/Alberta Tactical Rifle Supply specializes in custom precision rifle manufacture, upgrades and modifications.

Action

- gas operated.

Calibre

- 308 WIN 1:10 and "ATRS" may be found marked on the barrel.

Shots

- detachable box magazine.
- the magazine well of the ATR Modern Hunter is of an early (first generation) AR-10 design, and will accept early AR-10 magazines and the Stoner SR-25 magazine.
- late model AR-10 magazines do not fit and function in this firearm.

Serial Number

- serial number rationalization as follows: - the ATRS prefix is an abbreviation of the manufacturer's brand name, Alberta Tactical Rifle Supply; followed by 2 digits indicating the year of manufacture, followed by the Roman alphabet letters "MH" denoting the model - "Modern Hunter"; with the final six (6) numbers being the firearm's unique serial number within the Modern Hunter series production.
- serial number was observed marked on the right side of the magazine housing of the lower receiver/frame.
- observed serial number consisted of a four letter prefix followed by a series of letters and numbers.

Canadian Law

Comments

- this firearm design is derived from an amalgamation of several different firearm designs and does not trace its design lineage directly or uniquely to a "prohibited" or a "restricted" firearm found in the Regulations appended to the Criminal Code.

Other Markings

- the trade name "Alberta Tactical Rifle" may be found marked upon the left side of the upper receiver.
- a stylized maple leaf and the word CANADA may be found marked on the right side of the upper receiver to the rear of the ejection opening.

Cross-References

Firearm Ref. No. Make	Model	Manufacturer	Type	Action
146190	Modern Hunter Prototype	Alberta Tactical Rifle	Rifle	Semi-Automatic
	Alberta Tactical Rifle			

Also Known As/Product Code

ATRS MH

MH



FRT Report

Network Version 3.18.0

Firearm Reference No.: 149826

Date: 2017/07/19
Page: 3 / 13

Year Dates

No Data Retrieved

Importer

No Data Retrieved



FRT Report

Network Version 3.18.0

Firearm Reference No.: 149826

Date: 2017/07/19

Page: 4 / 13

Firearm Details - Image

Make: Alberta Tactical Rifle
Model: Modern Hunter
Manufacturer: Alberta Tactical Rifle
Level: Manufacturer Specifications and Commercial Customization
Type: Rifle
Action: Semi-Automatic
Country of Manufacturer: CANADA

Full View: Left Side

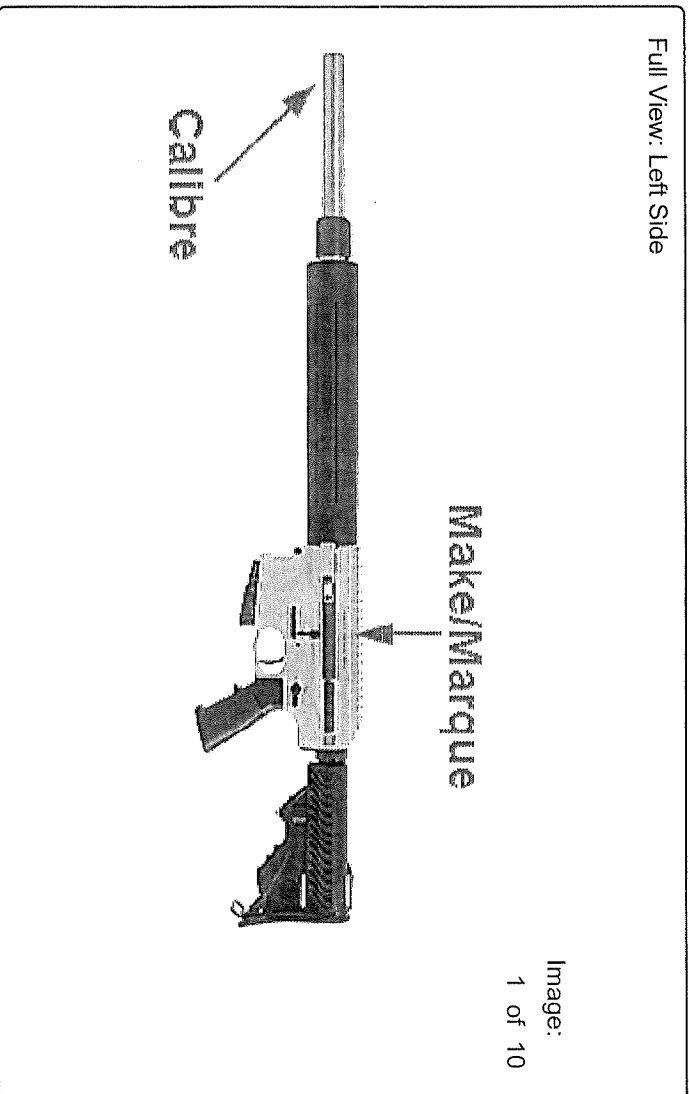



FRT Report

Network Version 3.18.0

Firearm Reference No.: 149826

Date: 2017/07/19
Page: 5 / 13

Firearm Details - Image

Make:	Alberta Tactical Rifle
Model:	Modern Hunter
Manufacturer:	Alberta Tactical Rifle
Level:	Manufacturer Specifications and Commercial Customization
Type:	Rifle
Action:	Semi-Automatic
Country of Manufacturer:	CANADA

Full View: Right Side

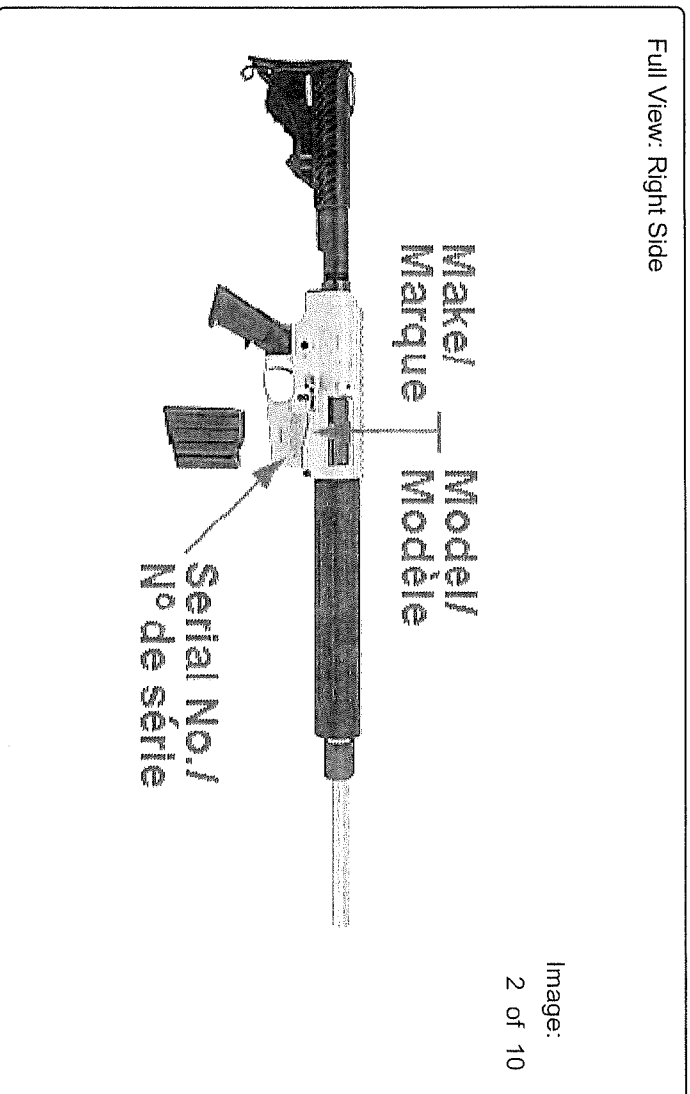



FRT Report

Network Version 3.18.0

Firearm Reference No.: 149826

Date: 2017/07/19

Page: 6 / 13

Firearm Details - Image

Make:	Alberta Tactical Rifle
Model:	Modern Hunter
Manufacturer:	Alberta Tactical Rifle
Level:	Manufacturer Specifications and Commercial Customization
Type:	Rifle
Action:	Semi-Automatic
Country of Manufacturer:	CANADA

Close-up #1: Left Side

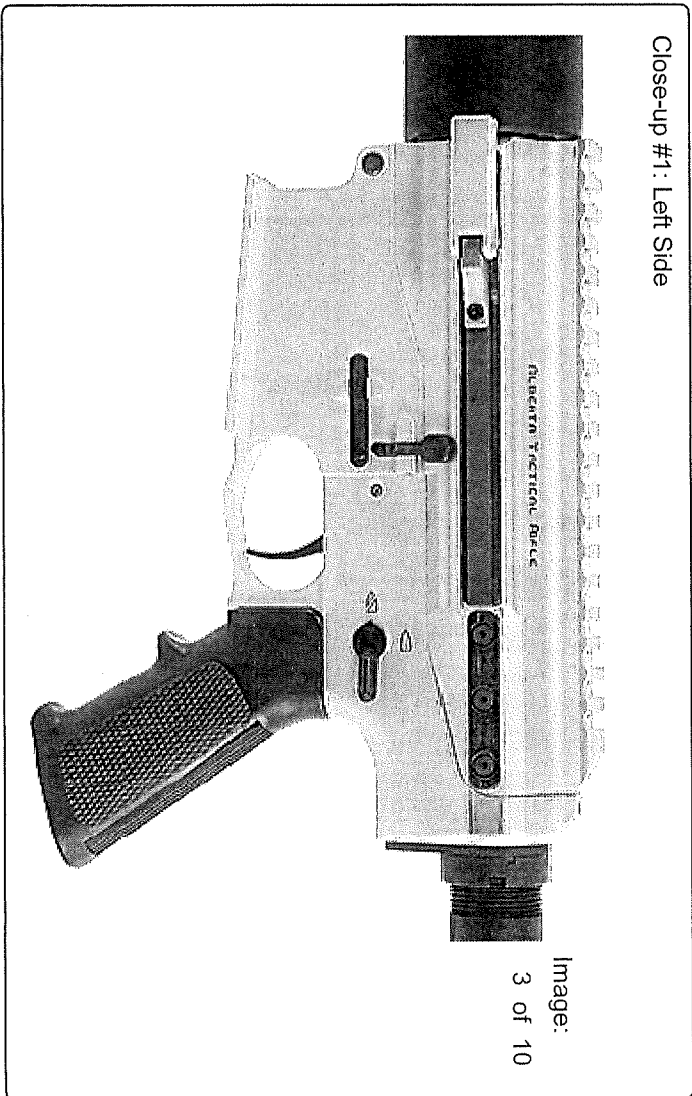



FRT Report

Network Version 3.18.0

Firearm Reference No.: 149826

Date: 2017/07/19

Page: 7 / 13

Firearm Details - Image

Make: Alberta Tactical Rifle
Model: Modern Hunter
Manufacturer: Alberta Tactical Rifle
Level: Manufacturer Specifications and Commercial Customization
Type: Rifle
Action: Semi-Automatic
Country of Manufacturer: CANADA

Close-up #2: Left Side

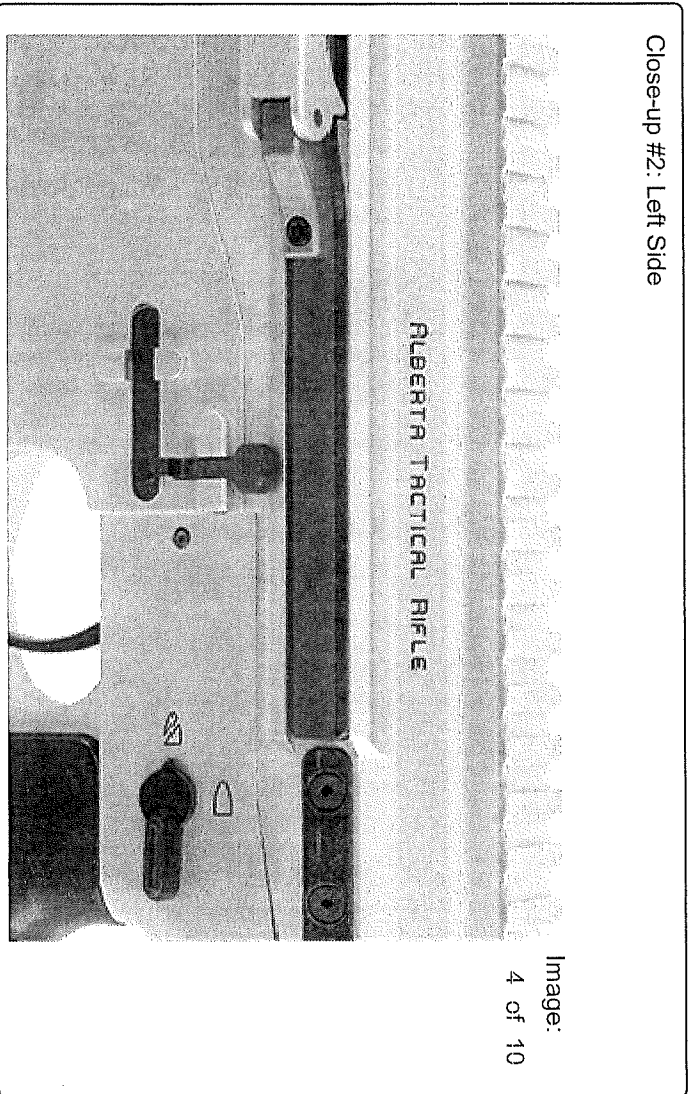



FRT Report

Network Version 3.18.0

Firearm Reference No.: 149826

Date: 2017/07/19

Page: 8 / 13

Firearm Details - Image

Make:	Alberta Tactical Rifle
Model:	Modern Hunter
Manufacturer:	Alberta Tactical Rifle
Level:	Manufacturer Specifications and Commercial Customization
Type:	Rifle
Action:	Semi-Automatic
Country of Manufacturer:	CANADA

Close-up #1: Right Side

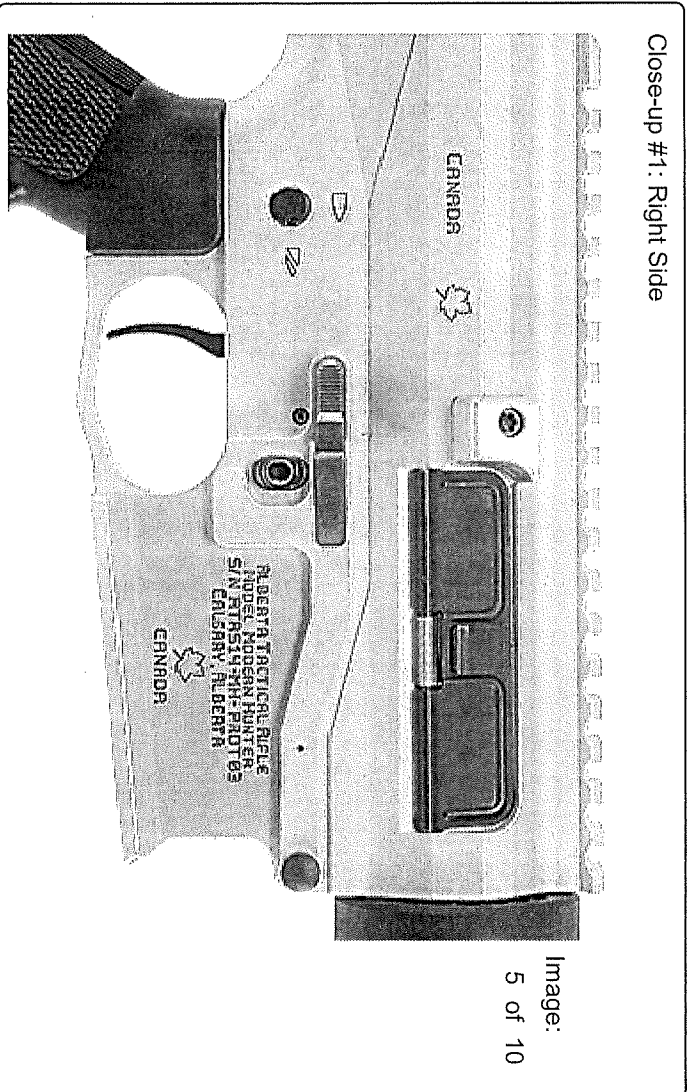



FRT Report

Network Version 3.18.0

Firearm Reference No.: 149826

Date: 2017/07/19

Page: 9 / 13

Firearm Details - Image

Make: Alberta Tactical Rifle
Model: Modern Hunter
Manufacturer: Alberta Tactical Rifle
Level: Manufacturer Specifications and Commercial Customization
Type: Rifle
Action: Semi-Automatic
Country of Manufacturer: CANADA

Close-up #2: Right Side

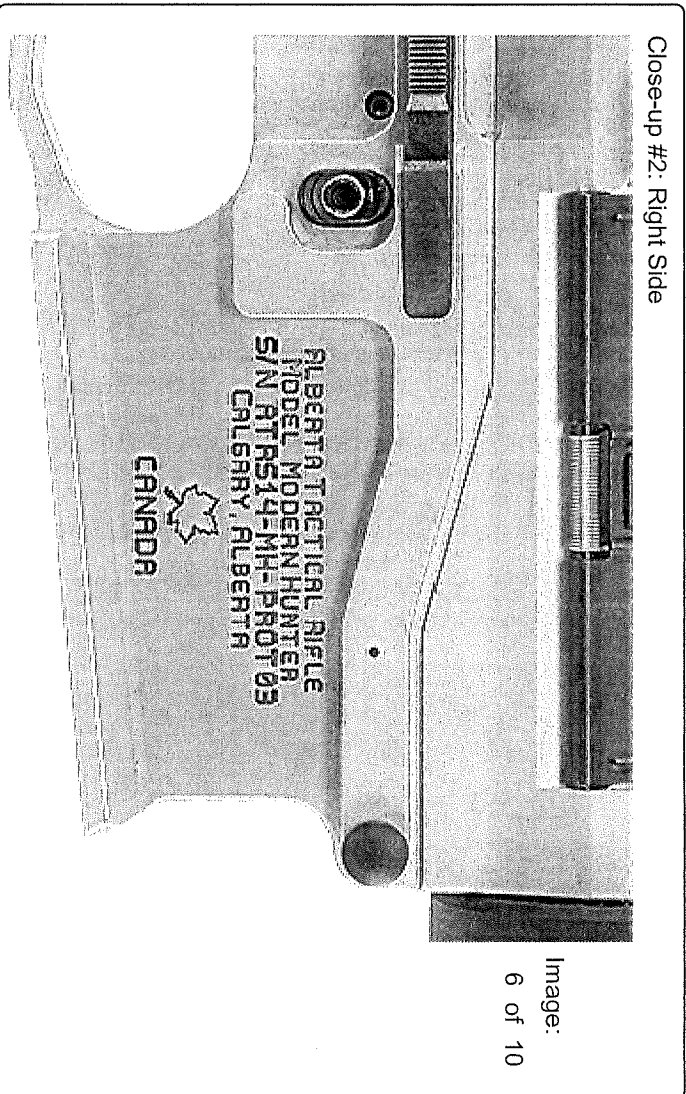

Image:
6 of 10



FRT Report

Network Version 3.18.0

Firearm Reference No.: 149826

Date: 2017/07/19
Page: 10 / 13

Firearm Details - Image

Make:	Alberta Tactical Rifle
Model:	Modern Hunter
Manufacturer:	Alberta Tactical Rifle
Level:	Manufacturer Specifications and Commercial Customization
Type:	Rifle
Action:	Semi-Automatic
Country of Manufacturer:	CANADA

Close-up #3: Right Side

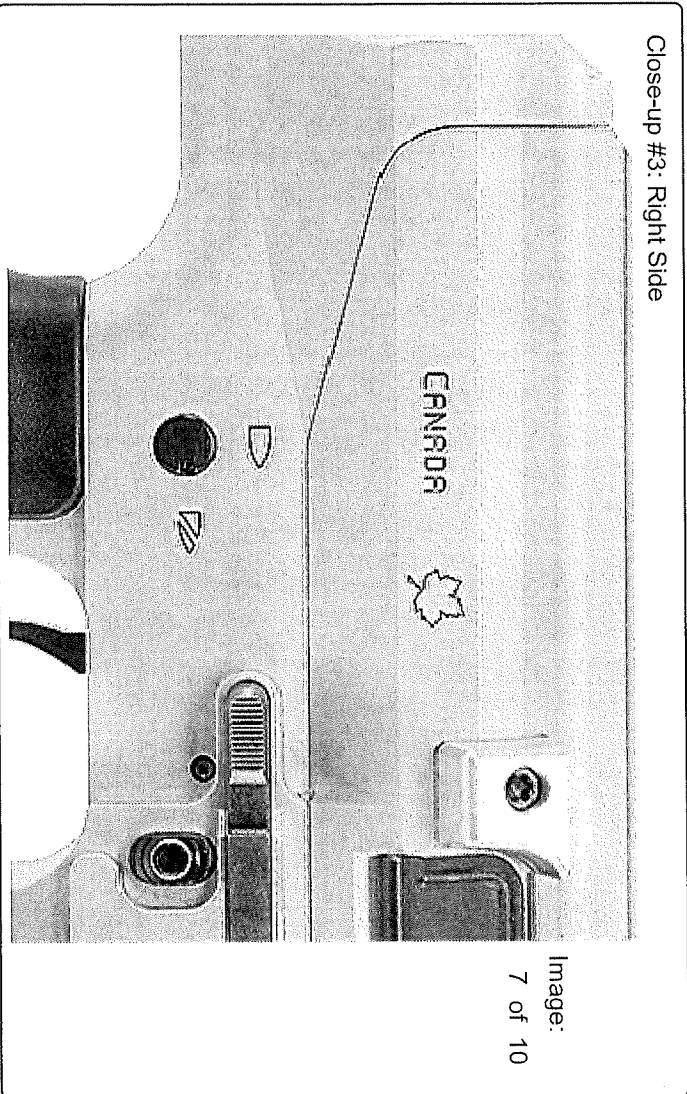



FRT Report

Network Version 3.18.0

Firearm Reference No.: 149826

Date: 2017/07/19

Page: 11 / 13

Firearm Details - Image

Make:	Alberta Tactical Rifle
Model:	Modern Hunter
Manufacturer:	Alberta Tactical Rifle
Level:	Manufacturer Specifications and Commercial Customization
Type:	Rifle
Action:	Semi-Automatic
Country of Manufacturer:	CANADA

Close-up #1: Bottom

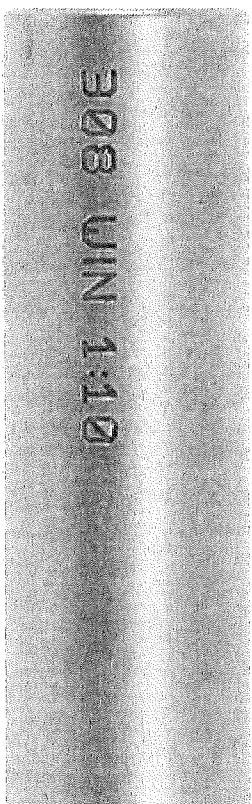

Image:
8 of 10



FRT Report

Network Version 3.18.0

Firearm Reference No.: 149826

Date: 2017/07/19

Page: 12 / 13

Firearm Details - Image

Make:	Alberta Tactical Rifle
Model:	Modern Hunter
Manufacturer:	Alberta Tactical Rifle
Level:	Manufacturer Specifications and Commercial Customization
Type:	Rifle
Action:	Semi-Automatic
Country of Manufacturer:	CANADA

Close-up #2: Bottom

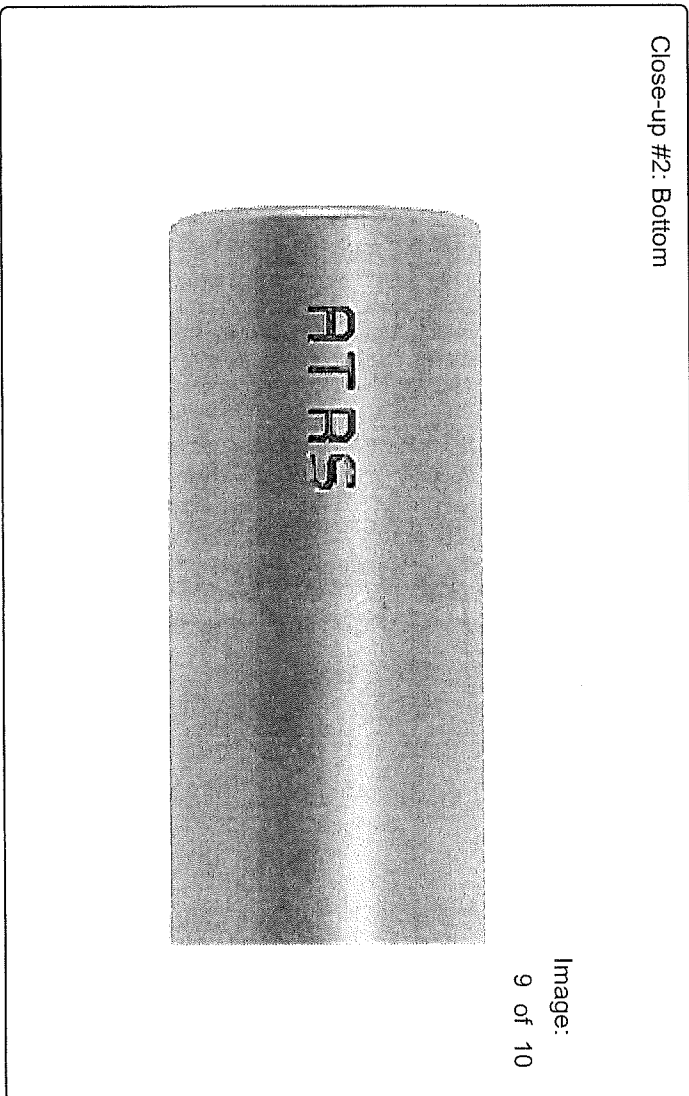



FRT Report

Network Version 3.18.0

Firearm Reference No.: 149826

Date: 2017/07/19

Page: 13 / 13

Firearm Details - Image

Make:	Alberta Tactical Rifle
Model:	Modern Hunter
Manufacturer:	Alberta Tactical Rifle
Level:	Manufacturer Specifications and Commercial Customization
Type:	Rifle
Action:	Semi-Automatic
Country of Manufacturer:	CANADA

Close-up #1: Top

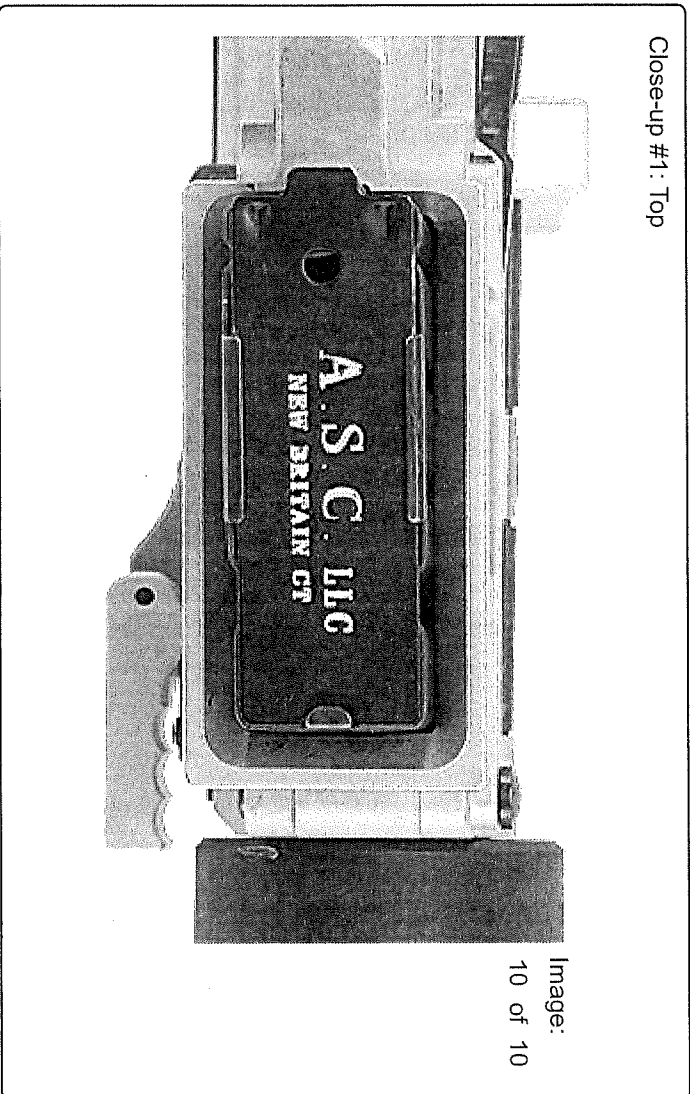

Image:
10 of 10

This is **Exhibit "C"** referred to in the Affidavit of Rick Timmins, sworn before me this 10
day of September, 2020.



A Commissioner for Oaths in and for the
Province of Alberta

**INSPECTION REPORT
ALBERTA TACTICAL RIFLE
MODEL MODERN HUNTER
SERIAL NUMBER - ATRS14-MH-PROT03
CASE NUMBER GFC-2000-7-1-149826**

2015-01-08

SUBJECT AND PURPOSE OF INSPECTION

Alberta Tactical Rifle, Model - Modern Hunter, S/N ATRS14-MH-PROT03.



FIG -1

1. Specialized Firearms Support Services (SFSS) requested an inspection to determine the legal classification of the production model of the subject firearm.

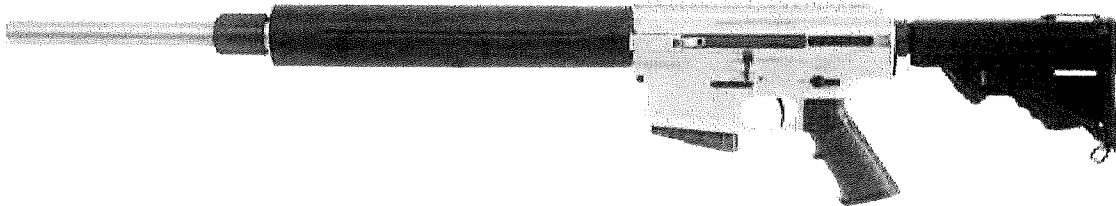

FIG -2 - Alberta Tactical Rifle, Model - Modern Hunter, S/N ATRS14-MH-PROT03

DESCRIPTION

The firearm as received at Specialized Firearms Support Services Section:

Make: Alberta Tactical Rifle
Manufacturer: Alberta Tactical Rifle
Model: Modern Hunter
Caliber: 308Win
Barrel length: 368mm
S/N: ATRS14-MH-PROT03
FRT # 149826
Fin : N/A
Certificate : N/A

SCHEDULE

2. On 2014-10-27, Specialized Firearms Support Services (SFSS) received a production version of the Modern Hunter Model firearm from Rick Timmins of Alberta Tactical Rifle, on 2014-12-11 a formal examination commenced and was completed 2015-01-08, images were taken during the 2014-12-11 to 2015-01-08 time period.

FINDINGS

1. The Alberta Tactical Rifle, Model Modern Hunter Rifle undergoing inspection has a purpose built semi-automatic rifle receiver/frame. This receiver has been machined in accordance with US BATF requirements for similar Armalite style firearms; the rear portion of the trigger well is narrowed (.6220in-15.79mm) so an automatic sear cannot be installed, as shown in Fig -2.

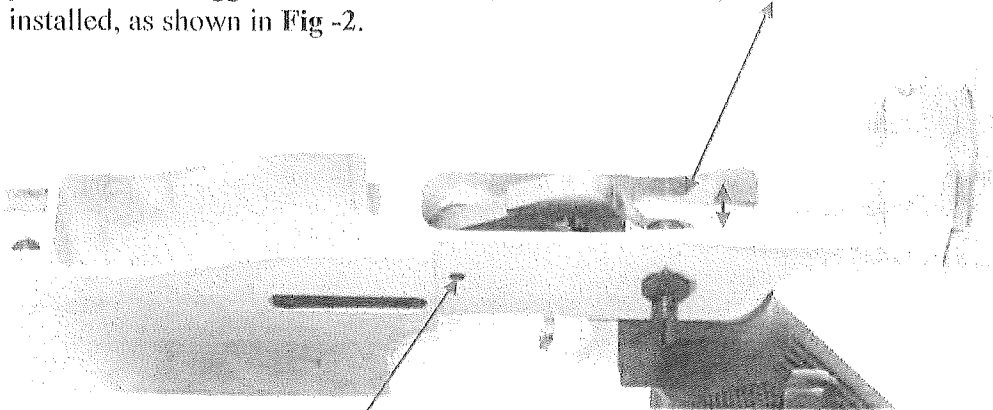

Fig -2

2. The ATR Modern Hunter uses a Timney, AR-10 self-contained drop in trigger unit with single hammer pin mounting system. The trigger well is machined to fit mil-spec AR-10, trigger and hammer parts, (as this particular mechanism has a self-contained trigger there is no trigger pin hole in the receiver) as shown in Fig -2.

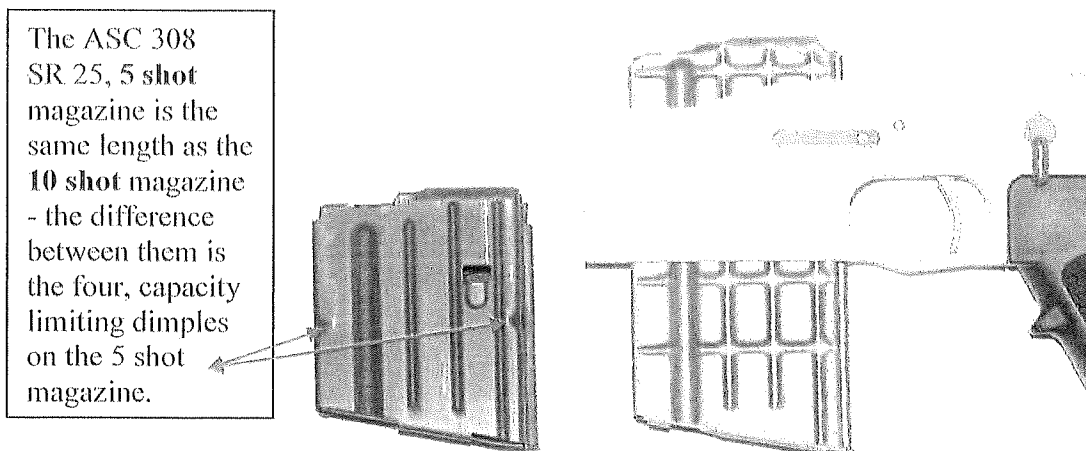

Fig -3 ASC, 308 cal (SR 25), 5 shots (first generation) AR-10 cartridge magazine

3. The magazine well of the ATR Modern Hunter is of an early (first generation) AR-10 design, and will fit early AR-10 magazines and the Stoner SR-25 magazine. Late model AR-10 magazines do not fit.
4. The ATR Modern Hunter arrived at SFSS equipped with a 5 shot, ASC 308 (SR 25), 5 shot magazine as shown on the left of Fig -3.



Fig -4 Bushmaster model - ACR



Fig -5 ATR model, Modern Hunter

5. The receiver/trigger mechanism housing group of an Alberta Tactical Rifle, Model, Modern Hunter resembles that of a Bushmaster ACR as shown in **Figs -4 & -5**.

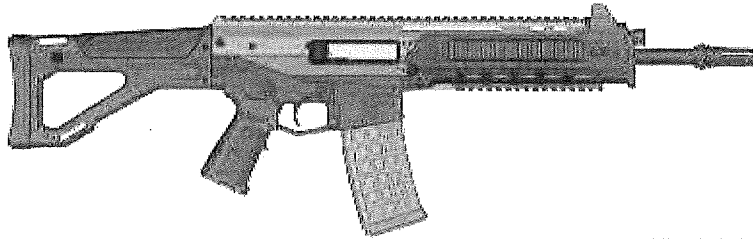

Fig -6 Bushmaster, model ACR



Fig -7

Late model AR-10 (top)

Early model AR-10 (center)

Alberta Tactical Rifle, Model Modern Hunter (bottom).

The Alberta Tactical Rifle, Model - Modern Hunter design has some features of the early model AR-10 (magazine) and some features of the late model AR-10 (magazine release, pistol grip, selector, hammer pin location and recoil buffer system). The ATR, - Modern Hunter receiver (trigger mechanism housing) will not mount to an AR-10 upper receiver.

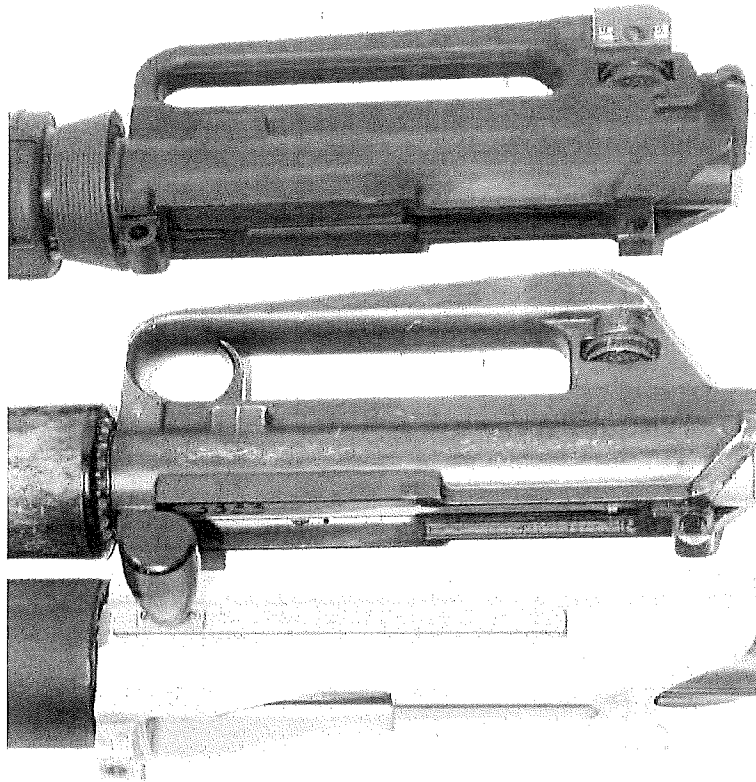

Fig -8

Late model AR-10 (top)

Early model AR-10 (center)

ATR, Modern Hunter
(bottom)

The Alberta Tactical Rifle Model Modern Hunter has some features of the early model AR-10 (gas system) and some features of the late model AR-10 like the (Bolt, carrier and firing pin assembly).

The ATR Modern Hunter is not a hinged receiver design and does not have mounting pins.

The ATR Modern Hunter upper receiver will not mount to an AR-10 lower receiver.

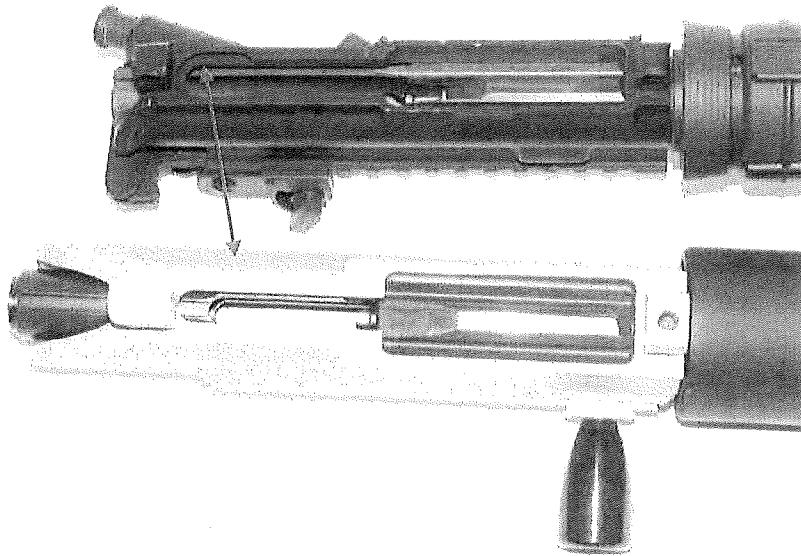

Fig -9

6. As shown in **Fig -2**, the ATR, Model - Modern Hunter upper receiver does not have a cut for an automatic sear, (as seen on the AR 15 upper receiver above) and has a different mounting system for the upper receiver to the lower receiver / frame than either the AR-10 or AR-15 Rifles. (**Fig -9**)

CONCLUSION

1. As received at Specialized Firearms Support Services Section, the Make - Alberta Tactical Rifle, Model - Modern Hunter, serial number ATRS14-MH-PROT03 contains the receiver / frame of a semi-automatic firearm. Further, this firearm design is derived from an amalgamation of several different firearm designs and does not trace its design lineage directly or uniquely to a "prohibited" or a "restricted" firearm found in the Regulations appended to the Criminal Code.
2. As inspected by RCMP - Specialized Firearms Support Services Section, The Alberta Tactical Rifle, Model - Modern Hunter Rifle is a non-restricted firearm which may be found at FRT # 149826.

2015-01-08

REPORT REVIEWED BY

William Etter
Chief Firearms Technologist
Specialized Firearms Support Services
Firearms Investigative & Enforcement Services Directorate
RCMP - CFP
Specialized Policing Services

This is **Exhibit "D"** referred to in the Affidavit of Rick Timmins, sworn before me this 10 day of September, 2020.



A Commissioner for Oaths in and for the
Province of Alberta

RCMP-GRC



ROYAL CANADIAN MOUNTED POLICE • GENDARMERIE ROYALE DU CANADA

FIREARMS REFERENCE TABLE (PUBLIC VERSION)

CANADIAN FIREARMS PROGRAM



Royal Canadian Mounted Police
Gendarmerie royale du Canada

Canada



The following link provides a list of the FRT Records in existence on May 1st, 2020, affected by the May 1st, 2020 Order in Council making the Regulations Amending the *Regulations Prescribing Certain Firearms and Other Weapons, Components and Parts of Weapons, Accessories, Cartridge Magazines, Ammunition and Projectiles as Prohibited, Restricted or Non-Restricted (SOR/2020-96)*. Should any additional variants be identified, this list will be updated.

[Click here to view the newly prohibited firearms](#)

You may experience technical difficulties viewing this file in certain browsers. For best viewing results, please download this file.

Legal disclaimer

This document is not a legal instrument. The FRT is an administrative document created by the RCMP's firearms experts who have, based on the definitions set out in the *Criminal Code* and the types of firearms prescribed in the *Regulations Prescribing Certain Firearms and Other Weapons, Components and Parts of Weapons, Accessories, Cartridge Magazines, Ammunition and Projectiles as Prohibited or Restricted (SOR/98-462)* and the *Firearms Act*, conducted technical assessments of firearms to assist law enforcement officers, customs officers, and officials responsible for the regulation of firearms with the identification and classification of firearms. The aforementioned Act and Regulations are the prevailing legal authority with respect to firearm classification.

© Her Majesty the Queen in Right of Canada, as represented by the Royal Canadian Mounted Police, 2020.

This is **Exhibit "E"** referred to in the Affidavit of Rick Timmins, sworn before me this 10
day of September, 2020.



A Commissioner for Oaths in and for the
Province of Alberta



Summary

Make: Alberta Tactical Rifle
Model: Modern Varmint
Manufacturer: Alberta Tactical Rifle
Level: Manufacturer Specifications and Commercial Customization
Type: Rifle
Action: Semi-Automatic
Country of Manufacturer: CANADA
Serial Numbering: See Note
Legal Classification: Non-Restricted

Calibre, Shots and Barrel Length

Firearm Ref. No.	Calibre	Shots	Barrel (mm)	Legal Classification	Legal Authority	Level	Barrel Type Code
162446 - 1	5.56MM NATO	5	480	Non-Restricted	CC 2 "firearm"	Manufacturer Specifications and Commercial Customization	
162446 - 2	6.5MM GRENDEL	5	508	Non-Restricted	CC 2 "firearm"	Manufacturer Specifications and Commercial Customization	

Notes

Make - the make "ALBERTIA TACTICAL RIFLE" was observed on a referenced example, marked on the right side of the magazine housing of the receiver/frame and on the left side of the firearm.

Model

- introduced in 2015.
- model designation "MODEL MODERN VARMINT" was observed marked on the right side of the magazine housing of the receiver/frame.
- features include: 5.56mm Wyld (long freebore) Chamber, free floating, round, stainless steel, heavy barrel; round alloy forend; no sights; integral sight rail on upper receiver; folding charging handle located on the left side of the upper receiver; magazine mounted in front of the trigger guard; pistol grip; two position safety located on the left side of the frame/receiver above the pistol grip; collapsible stock.
- the sample receiver had an unfinished bead blasted alloy silver finish.
- the ATRS Modern Varmint accepts most AR-15 parts and accessories.
- the ATRS Modern Varmint uses a Timney AR-15 self-contained drop in trigger unit with single hammer pin mounting system. The rear of the trigger unit is retained by a screw that is accessed by removing the pistol grip.
- the trigger well in the lower receiver is machined to fit mil-spec AR-15 trigger and hammer parts, however this particular firearm receiver has a self-contained trigger mechanism which mounts on the hammer axis pin, there is no trigger pin hole in the receiver.
- the ATRS, Model - Modern Varmint upper receiver does not have a cut for an automatic sear, and has a different system for mounting upper to lower receivers than either the AR-10 or AR-15 Rifles.
- overall length of firearm butt collapsed 859mm.
- overall length of firearm butt extended 955mm.



FRT Report

Network Version 3.18.0

Firearm Reference No.: 162446

Date: 2017/07/19

Page: 2 / 7

Manufacturer

- the make "ALBERTA TACTICAL RIFLE" was observed on a referenced example, marked on the right side of the magazine housing of the receiver/frame and on the left side of the firearm.

Action

- gas operated

Calibre

- ".223 Wyld" calibre is marked on the barrel of this firearm. This designation is not the calibre of the firearm but a description of the chamber dimensions. - the Wyld chamber is identical to the NATO STANAG chamber with a longer freebore to accommodate .224 inches (5.6MM) diameter commercial projectiles up to 80grs (5.18gm) mass. The rifling twist is 1 turn in 9 inches (1 turn in 229mm) to stabilize projectiles with a greater mass than 55 grs without incurring the pressure spike of engaging a long projectile bearing surface at full rifling depth.

Shots

- detachable box magazine.
- firearm designed to utilize AR15/M16 STANAG "type" cartridge magazines.

Serial Number

- serial number rationalization as follows: - the ATRS prefix is an abbreviation of the manufacturer's brand name, Alberta Tactical Rifle Supply, followed by 2 digits - indicating the year of manufacture, followed by the Roman alphabet letters "MV" denoting the model - "Modern Varmint"; with the final six (6) digits being the firearm's unique serial number within the Modern Varmint series production.
- serial number was observed marked on the right side of the magazine housing of the lower receiver/frame.
- observed serial number consisted of a four letter prefix followed by a series of letters and numbers.

Canadian Law

- this firearm design is derived from an amalgamation of several different firearm designs and does not trace its design lineage directly or uniquely to a "prohibited" or a "restricted" firearm found in the Regulations appended to the Criminal Code.

Other Markings

- the trade name "Alberta Tactical Rifle" may be found marked upon the left side of the upper receiver.
- a stylized maple leaf and the word CANADA may be found marked on the right side of the upper receiver to the rear of the ejection opening.

Cross-References

Firearm Ref. No.	Make	Model	Manufacturer	Type	Action
149826	Modern Hunter	Alberta Tactical Rifle	Alberta Tactical Rifle	Rifle	Semi-Automatic

Also Known As/Product Code

- ATR Model Modern Varmint
- ATR Modern Varmint
- ATRS Model Modern Varmint
- ATRS Modern Varmint
- Model Modern Varmint

Year Dates

No Data Retrieved

Importer

No Data Retrieved



FRT Report

Network Version 3.18.0

Firearm Reference No.: 162446

Date: 2017/07/19

Page: 3 / 7

Firearm Details - Image

Make: Alberta Tactical Rifle
Model: Modern Varmint
Manufacturer: Alberta Tactical Rifle
Level: Manufacturer Specifications and Commercial Customization
Type: Rifle
Action: Semi-Automatic
Country of Manufacturer: CANADA

Full View: Left Side

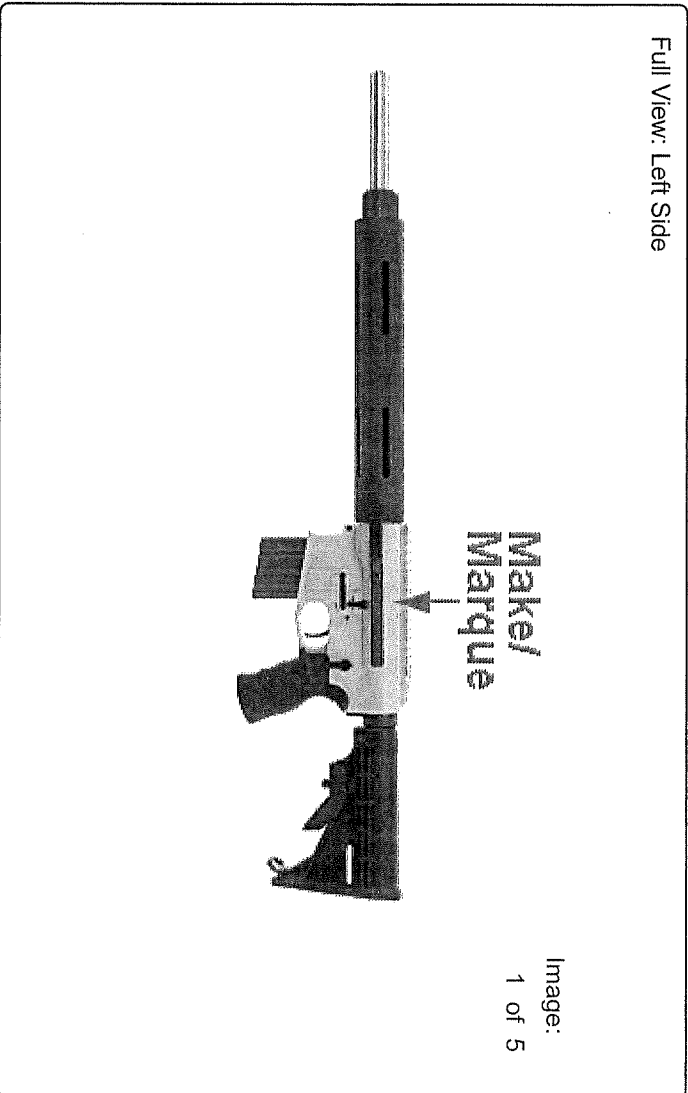



FRT Report

Network Version 3.18.0

Firearm Reference No.: 162446

Date: 2017/07/19

Page: 4 / 7

Firearm Details - Image

Make:	Alberta Tactical Rifle
Model:	Modern Varmint
Manufacturer:	Alberta Tactical Rifle
Level:	Manufacturer Specifications and Commercial Customization
Type:	Rifle
Action:	Semi-Automatic
Country of Manufacturer:	CANADA

Full View: Right Side

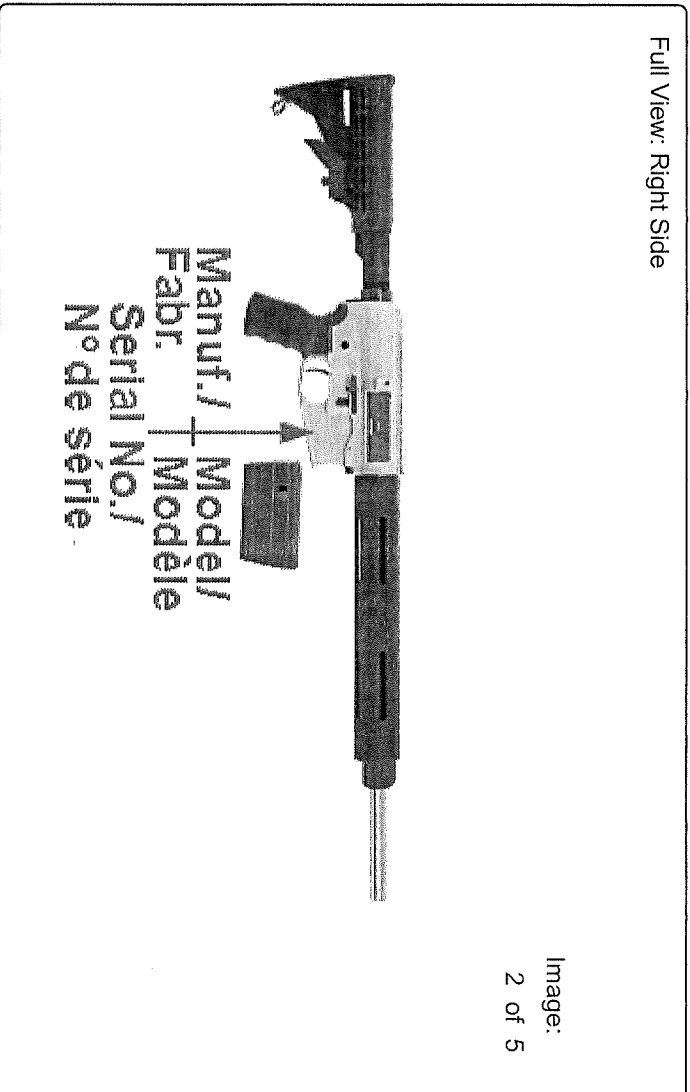



FRT Report

Network Version 3.18.0

Firearm Reference No.: 162446

Date: 2017/07/19

Page: 5 / 7

Firearm Details - Image

Make:	Alberta Tactical Rifle
Model:	Modern Varmint
Manufacturer:	Alberta Tactical Rifle
Level:	Manufacturer Specifications and Commercial Customization
Type:	Rifle
Action:	Semi-Automatic
Country of Manufacturer:	CANADA

Close-up: Left Side

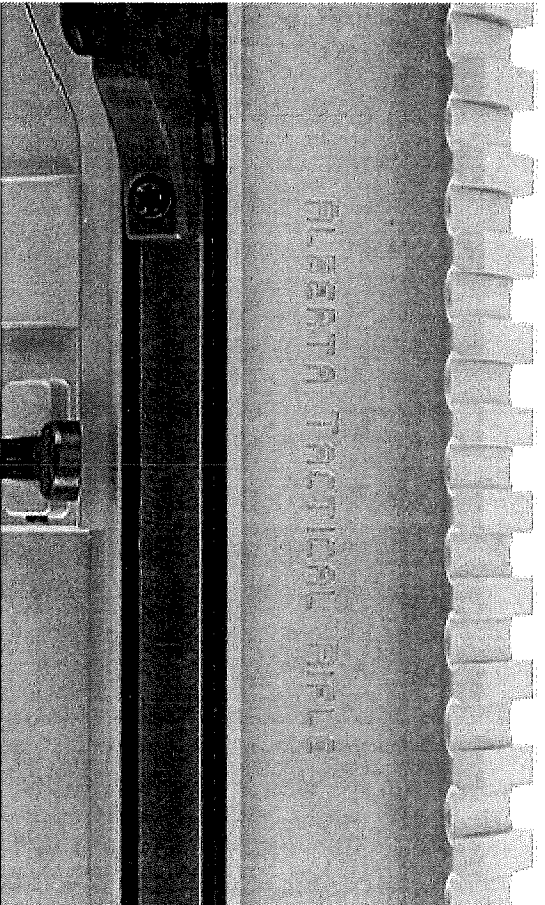

Image:
3 of 5



FRT Report

Network Version 3.18.0

Firearm Reference No.: 162446

Date: 2017/07/19
Page: 6 / 7

Firearm Details - Image

Make:	Alberta Tactical Rifle
Model:	Modern Varmint
Manufacturer:	Alberta Tactical Rifle
Level:	Manufacturer Specifications and Commercial Customization
Type:	Rifle
Action:	Semi-Automatic
Country of Manufacturer:	CANADA

Close-up #1 : Right Side

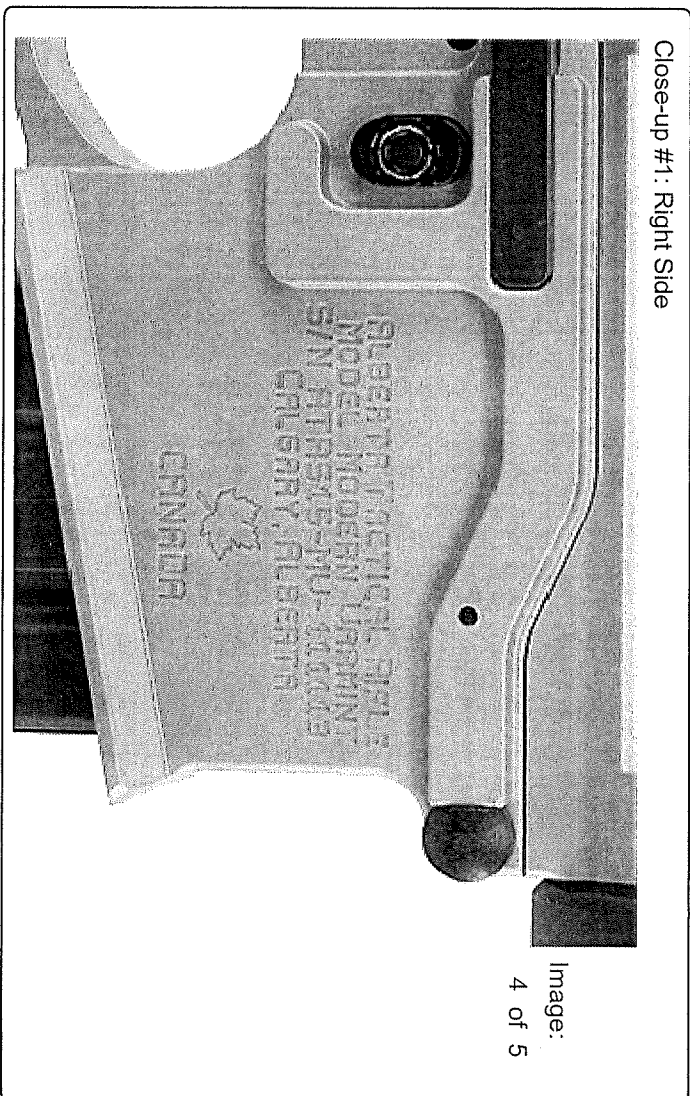



FRT Report

Network Version 3.18.0

Firearm Reference No.: 162446

Date: 2017/07/19
Page: 7 / 7

Firearm Details - Image

Make:	Alberta Tactical Rifle
Model:	Modern Varmint
Manufacturer:	Alberta Tactical Rifle
Level:	Manufacturer Specifications and Commercial Customization
Type:	Rifle
Action:	Semi-Automatic
Country of Manufacturer:	CANADA

Close-up #2: Right Side

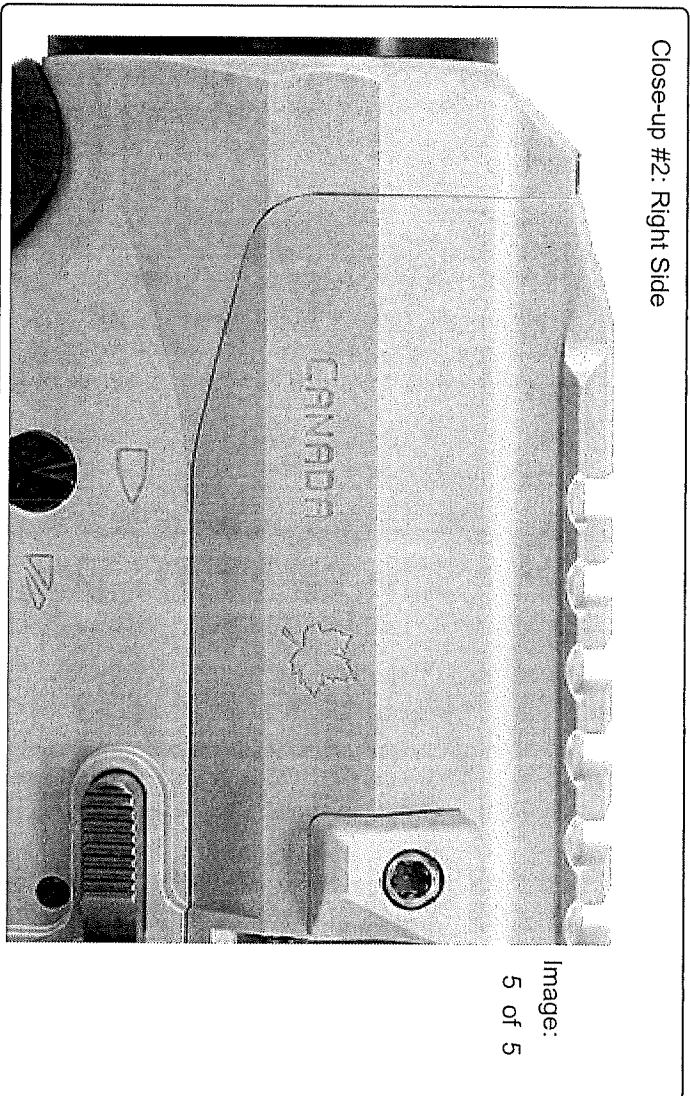

This is **Exhibit "F"** referred to in the Affidavit of Rick Timmins, sworn before me this 10
day of September, 2020.



A Commissioner for Oaths in and for the
Province of Alberta



Summary

Make: Alberta Tactical Rifle
Model: Modern Sporter
Manufacturer: Alberta Tactical Rifle
Level: Manufacturer Specifications and Commercial Customization
Type: Rifle
Action: Semi-Automatic
Country of Manufacturer: CANADA
Serial Numbering: See Note
Legal Classification: Non-Restricted

Calibre, Shots and Barrel Length

Firearm Ref. No.	Calibre	Shots	Barrel (mm)	Legal Classification Legal Authority	Level	Barrel Type Code
194622 - 1	5.56MM NATO	5	480	Non-Restricted CC 2 "firearm"	Manufacturer Specifications and Commercial Customization	

Notes

- Make** - the make "ALBERTA TACTICAL RIFLE" was observed on a referenced example, marked on the right side of the magazine housing of the receiver/frame and on the left side of the firearm.
- Model** - introduced in 2018.
- model designation "MODEL MODERN SPORTER" was observed marked on the right side of the magazine housing of the receiver/frame.
- features include: 5.56mm Wylde (long freebore) Chamber; free floating, round, stainless steel, heavy barrel; round alloy forend; no sights; integral sight rail on upper receiver; AR type charging handle located on top of the upper receiver; magazine mounted in front of the trigger guard; pistol grip; two position safety located on the left side of the frame/receiver above the pistol grip; collapsible stock.
- the sample firearm had an anodised matte black finish.
- the ATRS Modern Sporter accepts most AR-15 parts and accessories.
- the ATRS Modern Sporter can use any compatible AR-15 trigger mechanism.
- the trigger well in the lower receiver is machined to fit mil-spec AR-15 trigger and hammer parts.
- the ATRS, Model - Modern Sporter upper receiver does not have a cut for an automatic sear, and has a different system for mounting upper to lower receivers than either the AR-10 or AR-15 Rifles.
- overall length of observed firearm butt collapsed 865mm.
- overall length of observed firearm butt extended 960mm.
- Manufacturer** - the make "ALBERTA TACTICAL RIFLE" was observed on a referenced example, marked on the right side of the magazine housing of the receiver/frame and on the left side of the firearm.
- Action** - gas operated



FRT Report

Network Version 3.18.0

Firearm Reference No.: 194622

Date: 2018/10/04

Page: 2 / 3

Calibre	- ".223 Wylde" is marked on the barrel of this firearm. This designation is not the calibre of the firearm but a description of the chamber lead dimensions. - the Wylde chamber is identical to the NATO STANAG chamber with a longer freebore to accommodate .224 inches (5.6MM) diameter commercial projectiles up to 80grs (5.18gm) mass. The rifling twist is 1 turn in 9 inches (1 turn in 229mm) to stabilize projectiles with a greater mass than 55 grs without incurring the pressure spike of engaging a long projectile bearing surface at full rifling depth.
Shots	- detachable box magazine. - firearm designed to utilize AR15/M16 STANAG "type" cartridge magazines.
Serial Number	- serial number rationalization as follows: - the ATRS prefix is an abbreviation of the manufacturer's brand name, Alberta Tactical Rifle Supply, followed by 2 digits - indicating the year of manufacture, followed by the Roman alphabet letters "MS" denoting the model - "Modern Sporter", with the final six (6) digits being the firearm's unique serial number within the Modern Sporter series production. - serial number was observed marked on the right side of the magazine housing of the lower receiver/frame. - observed serial number consisted of a four letter prefix followed by a series of letters and numbers.
Canadian Law Comments	- the ATRS, Model - Modern Sporter upper receiver does not have a cut for an automatic sear, and has a different system for mounting upper to lower receivers than either the AR-10 or AR-15 Rifles. - as received at Specialized Firearms Support Services Section, the Make - Alberta Tactical Rifle, Model - Modern Sporter, serial number ATRS18-MS-000009 contains the receiver / frame of a semi-automatic firearm. Further, this firearm design is derived from an amalgamation of several different firearm designs and does not trace its design lineage directly or uniquely to a "prohibited" or a "restricted" firearm found in the Regulations appended to the Criminal Code.

Cross-References

Firearm Ref. No.	Make	Model	Manufacturer	Type	Action
149826		Modern Hunter		Rifle	Semi-Automatic
	Alberta Tactical Rifle		Alberta Tactical Rifle		
162446		Modern Varmint		Rifle	Semi-Automatic
	Alberta Tactical Rifle		Alberta Tactical Rifle		

Also Known As/Product Code

- ATR MODEL MODERN SPORTER
- ATR MODERN SPORTER
- ATRS MODEL MODERN SPORTER
- ATRS MODERN SPORTER
- MODEL MODERN SPORTER

Year Dates

No Data Retrieved

Importer

No Data Retrieved



FRT Report
Network Version 3.18.0

Firearm Reference No.: 194622

Date: 2018/10/04
Page: 3 / 3

This is **Exhibit "G"** referred to in the Affidavit of Rick Timmins, sworn before me this 10 day of September, 2020.



A Commissioner for Oaths in and for the
Province of Alberta



INSPECTION REPORT

CASE NUMBER: GFC-2000-7-1-194622

Alberta Tactical Rifle Supply, Model Modern Sporter

S/N: ATRS18-MS-000009

2018-10-04



**Fig. 1 – Alberta Tactical Rifle Supply, Model Modern Sporter,
Serial Number ATRS18-MS-000009**

SUBJECT AND PURPOSE OF INSPECTION

The subject of this inspection is an Alberta Tactical Rifle, Model Modern Sporter, Serial Number ATRS18-MS-000009. The ATRS Modern Sporter rifle is a centrefire, gas operated, air cooled, detachable box magazine fed, semi-automatic rifle that fires from a closed bolt.

DESCRIPTION

The receiver bears the markings:

“ALBERTA TACTICAL RIFLE”

“MODEL MODERN SPORTER”

“S/N ATRS18-MS-000009”

“CALGARY ALBERTA”

“CANADA”

The Receiver also bears a maple leaf emblem – as follows:

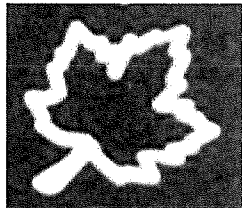

Make:	Alberta Tactical Rifle
Manufacturer:	Alberta Tactical Rifle Supply
Model:	Modern Sporter
Calibre:	Accepts both 5.56mm NATO and .223 Remington Cartridges (Wylde Chamber – long leade)
Barrel length:	480 MM
Overall Length:	960 MM (stock extended), 865 MM (stock collapsed)
S/N:	ATRS18-MS-000009
FRT #:	194622

SCHEDULE

On 2018-04-14 Specialized Firearms Support Services (SFSS) received an Alberta Tactical Rifle Model Modern Sporter manufactured by Alberta Tactical Rifle, Serial Number ATRS18-MS-000009. On 2018-09-18 a formal examination commenced and was completed on 2018-10-04. Inspection images were taken on 2018-09-18.

CONDITION OF RECEIPT

As received by, RCMP - Specialized Firearms Support Services (SFSS) the Alberta Tactical Rifle Modern Sporter, serial number ATRS18-MS-000009:

- a) arrived at SFSS in an aluminium transit case;
- b) did not come with a magazine; and,
- c) was received with areas with cosmetic damage on the firearm's finish.

PURPOSE OF INSPECTION

The purpose of this inspection was to determine the legal classification of the sample ATRS Modern Sporter Rifle, S/N ATRS18-MS-000009. This firearm appears to be a more cost effective version of the two previous Alberta Tactical Rifles, the ATRS, Modern Hunter and the ATRS, Modern Varmint. The ATRS Modern Sporter is specifically designed to make use of some of the commonly available modular components of the "AR Family of Firearms" to save the cost of producing, the equivalent proprietary ATRS components. The purpose of the inspection is to determine whether the "improved" version of the ATRS rifle product (the ATRS Modern Sporter Rifle) is a variant or modified version of an M-16 / AR-15 firearm.

CONCLUSIONS

1. The ATRS Modern Sporter, Serial Number ATRS18-MS-000009 incorporates design features from several different firearm designs (such as the Armalite AR-10) and is not a variant of any firearm found named in the Regulations appended to the Criminal Code PART III, Section 84 to be "prohibited.
2. The Alberta Tactical Rifle Model Modern Sporter is of the same basic design of the ATRS Model Modern Varmint Rifle, with slight modifications to make it more compatible with readily available cost effective AR-15 parts. There is an obvious similarity to the ATRS Model Modern Varmint and ATRS Modern Hunter, both of which are non-restricted firearms.



3. The Modern Sporter is not a variant or modified version of any firearm found named in the Regulations appended to the Criminal Code PART III, Section 84 to be “restricted”. The ATRS Modern Sporter Rifle has a barrel in excess of 470 mm in length and an over-all length in excess of 660 mm. The ATRS Modern Sporter Rifle as a newly manufactured, center-fire semi-automatic rifle having a barrel length of 480 mm and an overall length of 865mm with butt collapsed, falls into the **Non-Restricted** legal class.
4. The ATRS Modern Sporter Rifle, Serial Number ATRS18-MS-000009 can be found at FRT # 194622.

REPORT RELEASED BY

2018-10-04

F.A. William ETTER
Chief Firearms Technologist
Specialized Firearms Support Services
Firearms Investigative & Enforcement Services Directorate
RCMP – CFP – Specialized Policing Services

This is **Exhibit "H"** referred to in the Affidavit of Rick Timmins, sworn before me this 10
day of September, 2020.



A Commissioner for Oaths in and for the
Province of Alberta



Summary

Make: Alberta Tactical Rifle
 Model: Modern Hunter
 Manufacturer: Alberta Tactical Rifle
 Country of Manufacturer: Canada
 Type: Rifle
 Action: Semi-Automatic
 Legal Classification: Prohibited
 (Frame or Receiver Only)
 Category: Manufacturer Specifications and Commercial Customization

Calibre, Shots and Barrel Lengths

Sub-PRN	Calibre	Shots	Barrel Length (mm)	Legal Classification by Legal Authorities	Barrel Type	Prohibited Devices	Category
149825-2	243 WIN	5	473	Prohibited • PFR, Part 1, para. 87			Manufacturer Specifications and Commercial Customization
149825-3	260 REM	5	473	Prohibited • PFR, Part 1, para. 87			Manufacturer Specifications and Commercial Customization
149825-4	308 WIN	5	473	Prohibited • PFR, Part 1, para. 87			Manufacturer Specifications and Commercial Customization
149825-1	308 WIN	5	550	Prohibited • PFR, Part 1, para. 87			Manufacturer Specifications and Commercial Customization
149825-5	358 FEDERAL	5	473	Prohibited • PFR, Part 1, para. 87			Manufacturer Specifications and Commercial Customization
149825-6	5.56MM CREEDMOOR	5	473	Prohibited • PFR, Part 1, para. 87			Manufacturer Specifications and Commercial Customization
149825-8	5.56MM CREEDMOOR	5	506	Prohibited • PFR, Part 1, para. 87			Manufacturer Specifications and Commercial Customization
149825-7	7MM-08 REM	5	473	Non-Positioned • CC 2 "Firearm"			Manufacturer Specifications and Commercial Customization

Firearms Reference Table, Specialized Policing Services, Royal Canadian Mounted Police, FRT Version 1.0, January 2020. All rights reserved. RCMP 1599-2020.



FRT Report
 FRT 1.0.0 - 2019-11-25
 Report Layout Version 1.0

Firearm Reference Number: 149828

Printed Date: 2020-05-15
 Page: 2 / 14
 Last Updated Date: 2020-05-15

Features Chart

No data

Importers

No data

Also Known As/Product Code

ATRS:MH
 MH

Cross References

FRN	Make	Model	Manufacturer	Type	Action
149190	Alberta Tactical Rifle	Modern Hunter Prototype	Alberta Tactical Rifle	Rifle	Semi-Automatic
132446	Alberta Tactical Rifle	Modern Varmint	Alberta Tactical Rifle	Rifle	Semi-Automatic
194822	Alberta Tactical Rifle	Modern Sporter	Alberta Tactical Rifle	Rifle	Semi-Automatic

No data

Notes

Firearms Reference Table, Specialized Policing Services, Royal Canadian Mounted Police, FRT Version 1.0, January 2020. All rights reserved, RCMP 1998-2020.



Action

- gas operated.

Calibre

- 303 WIN 110 and "ATRS" may be found marked on the barrel.

Make

- "ALBERTA TACTICAL RIFLE", "MODEL Modern Hunter", "CALGARY, ALBERTA", "outline of a maple leaf" and "CANADA" was observed marked on the right side of the magazine housing of the receiver/frame.

Manufacturer

- Alberta Tactical Rifle/Alberta Tactical Rifle Supply is located in Calgary, Alberta, Canada.
 - Alberta Tactical Rifle/Alberta Tactical Rifle Supply is a Division of Magnum Machine Limited.
 - Alberta Tactical Rifle/Alberta Tactical Rifle Supply specializes in custom precision rifle manufacture, upgrades and modifications.

Model

- introduced in 2015.
 - this firearm is a production version of the ATRS Model Modern Hunter firearm.
 - the ATRS Modern Hunter uses a Timney AR-10 self-contained drop in trigger unit with single hammer pin mounting system.
 - the trigger well in the lower receiver is machined to fit the AR-10, 15 trigger and hammer parts; however this particular firearm receiver has a self-contained trigger mechanism which mounts on the hammer axis pin, there is no trigger pin hole in the receiver.
 - the ATRS Model Modern Hunter upper receiver does not have a cut for an automatic sear, and has a different system for mounting upper to lower receivers than either the AR-10 or AR-15 Rifles.
 - overall length of firearm but collapsed 980mm.
 - overall length of firearm but extended 1030mm.

Other Markings

- the Trade name "Alberta Tactical Rifle" may be found marked upon the left side of the upper receiver.
 - a stylized maple leaf and the word "CANADA" may be found marked on the right side of the upper receiver to the rear of the ejection opening.

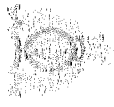

Notes

- detachable box magazine.
- the magazine well of the ATR Modern Hunter is of an early (first generation) AR-10 design, and will accept early AR-10 magazines and the Stoner SR-25 magazine.
- late model AR-10 magazines do not fit and function in this firearm.

Serial Number Comments

- serial number nomenclature as follows: - the ATR's prefix is an abbreviation of the manufacturer's brand name, Alberta Tactical Rifle Supply, followed by 2 digits - indicating the year of manufacture, followed by the Roman alphabet letters "A-M" denoting the model - "Modern Hunter", with the final six (6) numbers being the firearm's unique serial number within the Modern Hunter series production.
- serial number was observed marked on the right side of the magazine housing of the lower receiver/frame.
- observed serial number consisted of a four letter prefix followed by a series of letters and numbers.

Images

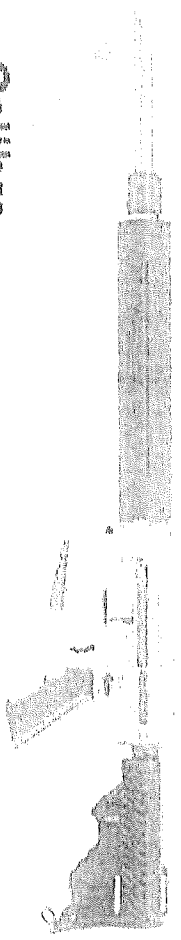

Firearm Reference Number

calibre



FRT Report
 FRT 1.0.0 - 2019-11-25
 Report Layout Version 1.0

Firearm Reference Number: 149828

Printed Date: 2020-05-15
 Page: 6 / 14
 Last Updated Date: 2020-05-15

Image: 2 of 10
 Image Description: Full View: Right Side

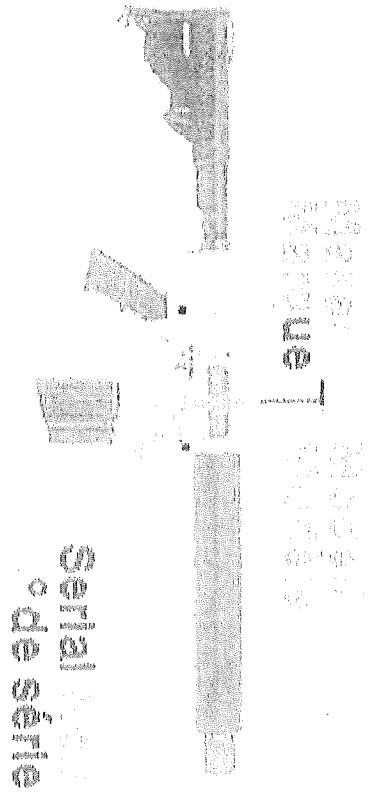



FRT Report
FRT 1.0.0 - 2019-11-25
Report Layout Version 1.0

Firearm Reference Number: 149828

Printed Date: 2020-05-15
Page: 7 / 14
Last Updated Date: 2020-05-15

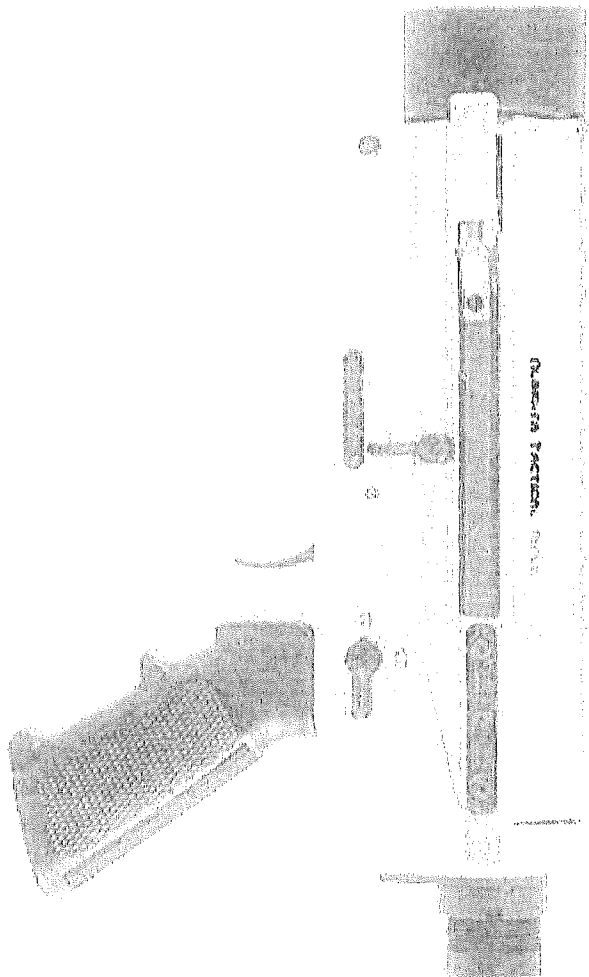

Image: 3 of 10
Image Description: Close-up #1: Left Side



FRT Report
FRT 1.0.0 - 2019-11-25
Report Layout Version 1.0

Firearm Reference Number: 149826

Printed Date: 2020-05-15

Page: 8 / 14

Last Updated Date: 2020-05-15

Image: 4 of 10

Image Description: Close-up #2: Left Side

MUSEUM TACTICAL TABLE

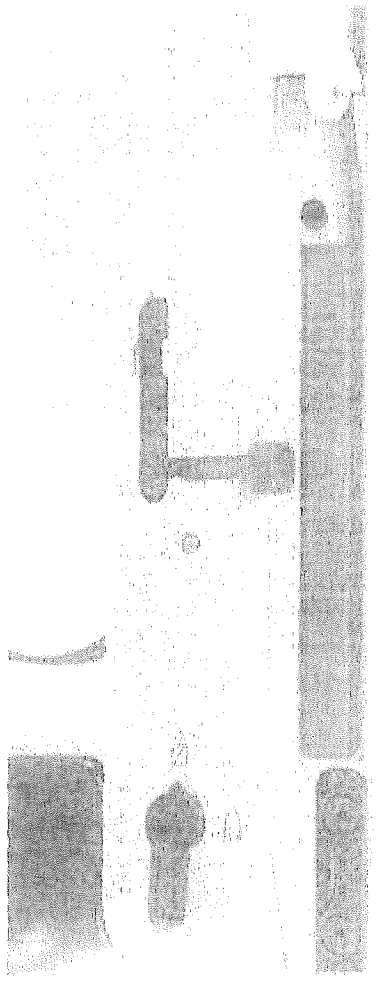



FRT Report
 FRT 1.0.0 - 2019-11-25
 Report Layout Version 1.0

Firearm Reference Number: 149825

Printed Date: 2020-05-15
 Page: 9 / 14
 Last Updated Date: 2020-05-15

Image: 5 of 10
 Image Description: Close-up #: Right Side

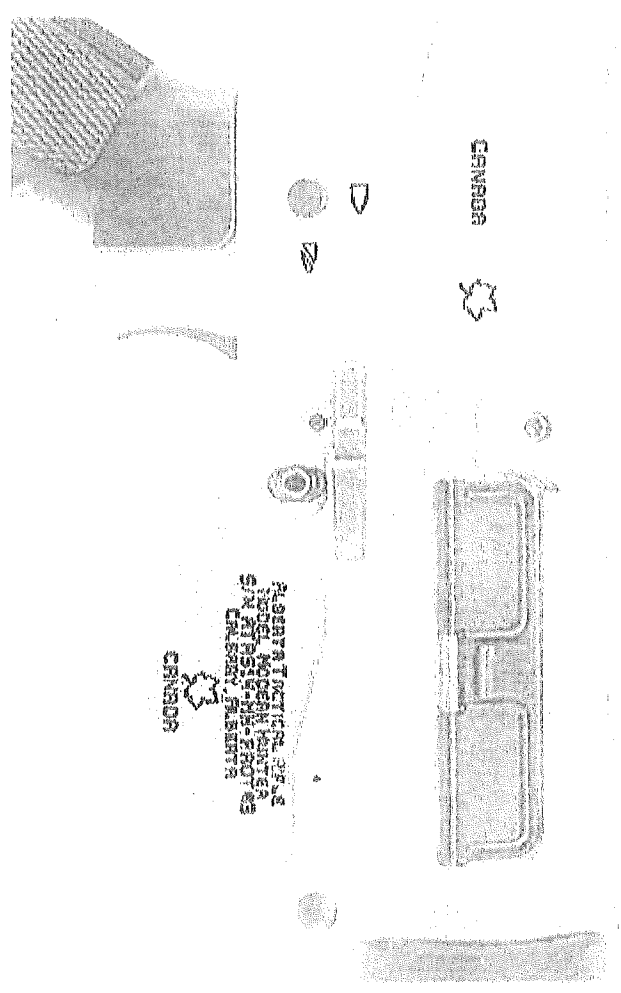

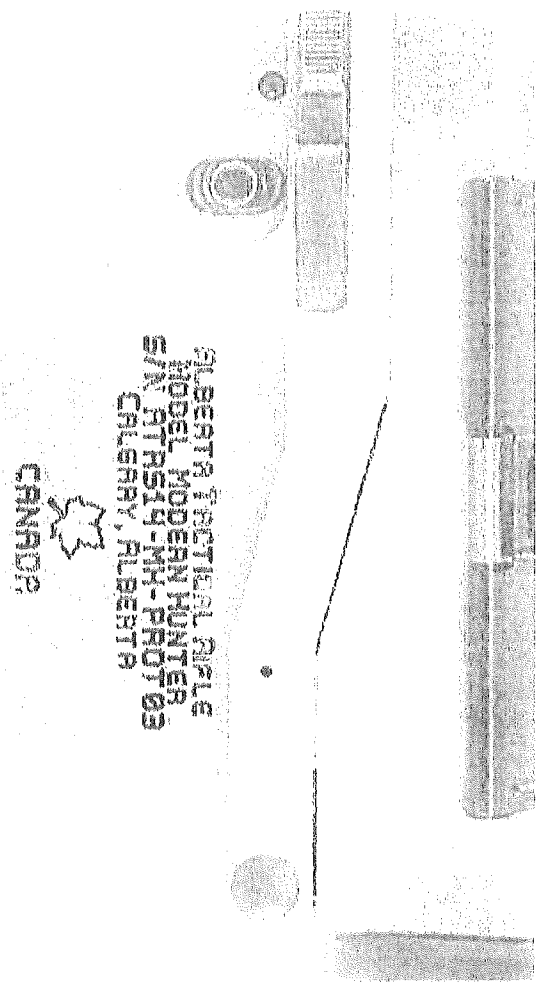

Image: 6 of 10
Image Description: Close-up #2: Right Side



FRT Report
FRT 1.0.0 - 2019-11-25
Report Layout Version 1.0

Firearm Reference Number: 149826

Printed Date: 2020-05-15
Page: 11 / 14
Last Updated Date: 2020-05-15

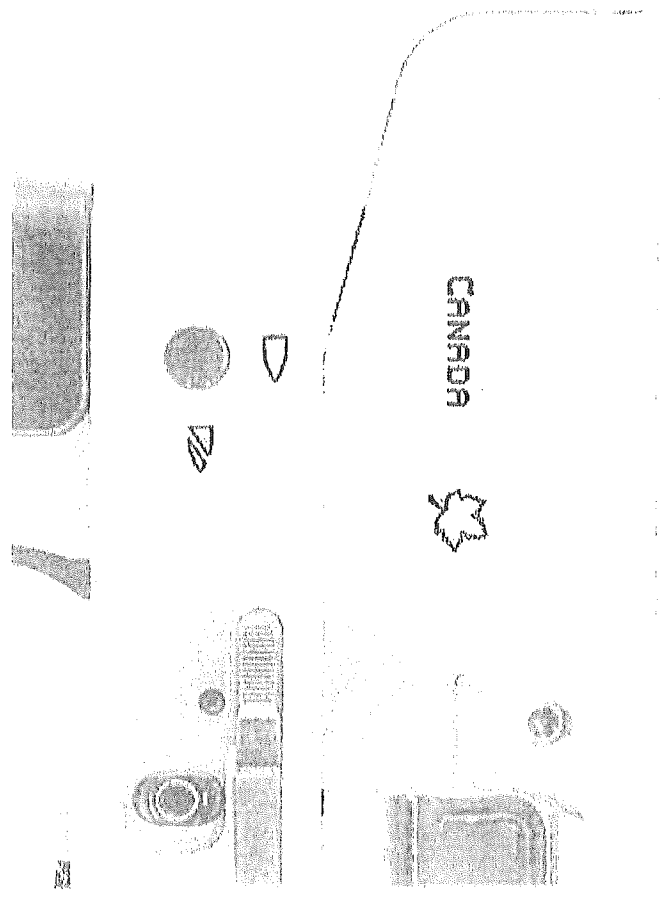

Image: 7 of 10
Image Description: Close-up #3: Right Side



FRT Report
FRT 1.0.0 - 2019-11-25
Report Layout Version 1.0

Firearm Reference Number: 149826

Printed Date: 2020-05-15
Page: 12/14
Last Updated Date: 2020-05-15

Image: 8 of 10
Image Description: Close-up #1: Bottom

308 WIN 110

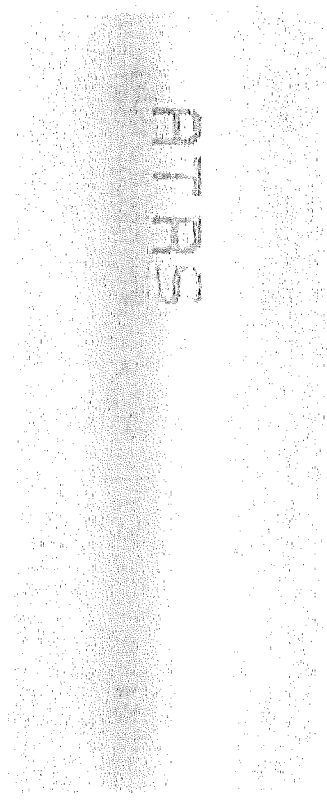

FRT Report

FRT 1.0.0 - 2019-11-25
Report Layout Version 1.0

Firmam Reference Number: 149825

Printed Date: 2020-05-15

Page: 14 / 14

Last Updated Date: 2020-05-15

Image: 10 of 10

Image Description: Close-up #1: Top

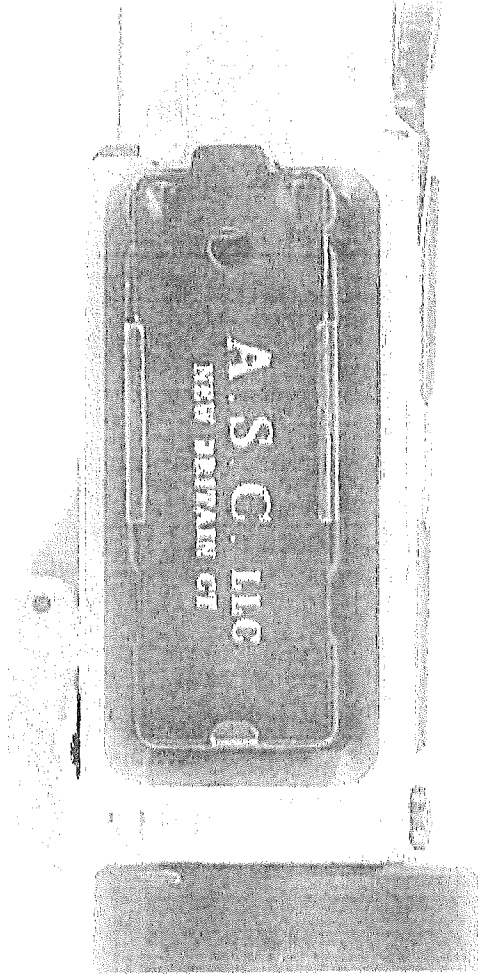

This is **Exhibit "I"** referred to in the Affidavit of Rick Timmins, sworn before me this 10
day of September, 2020.

A handwritten signature in blue ink, appearing to read "Smiller".

A Commissioner for Oaths in and for the
Province of Alberta



Summary

Make: Alberta Tactical Rifle
Model: Modern Varmint
Manufacturer: Alberta Tactical Rifle
Country of Manufacturer: Canada
Type: Rifle
Action: Semi-Automatic
Legal Classification: Prohibited
 (Frame or Receiver Only)
Category: Manufacturer Specifications and Commercial Customization

Calibre, Shots and Barrel Lengths

Sub-FRN	Calibre	Shots	Barrel Length (mm)	Legal Classification	Barrel Type	Prohibited Devices	Category
152446-1	6.5MM NATO	5	490	Prohibited * PFR, Part 1, para. 87			Manufacturer Specifications and Commercial Customization
152446-2	6.5MM GRENDEL	5	508	Prohibited * PFR, Part 1, para. 87			Manufacturer Specifications and Commercial Customization

Features Chart

No data

Importers

No data



FRT Report
 FRT 1.0.0 - 2019-11-25
 Report Layout Version 1.0

Firearm Reference Number 162446

Printed Date: 2020-05-15
 Page: 2 / 9
 Last Updated Date: 2020-05-15

Also Known As/Product Code

ATR Model Modern Varmint
 ATR Model Varmint
 ATRS Model Modern Varmint
 ATRS Model Varmint
 Model Modern Varmint

Cross References

FRN	Make	Model	Manufacturer	Type	Action
149029	Alberta Tactical Rifle	Modern Hunter	Alberta Tactical Rifle	Rifle	Semi-Automatic
194022	Alberta Tactical Rifle	Modern Sporter	Alberta Tactical Rifle	Rifle	Semi-Automatic

Year Data

No data

Notes

Action

- gas operated

Firearms Reference Table Specialized Policing Services, Royal Canadian Mounted Police, FRT version 1.0, January 2020. All rights reserved, RCMP, 1998-2020.



Calibre

- .223 Wyde calibre is marked on the barrel of this firearm. This designation is not the calibre of the firearm but a description of the chamber dimensions.
- the Wyde chamber is identical to the NATO STANAG chamber with a longer throat to accommodate .224 inches (5.69mm) diameter commercial projectiles up to 30grs (5.18grm) mass. The rifling twist is 1 turn in 9 inches (1 turn in 229mm) to stabilize projectiles with a greater mass than 35 grs without incurring the pressure spike of engaging a long projectile bearing surface at full rifling depth.

Make

- the make "ALBERTA TACTICAL RIFLE" was observed on a referenced example, marked on the right side of the magazine housing of the receiver/frame and on the left side of the firearm.

Manufacturer

- the make "ALBERTA TACTICAL RIFLE" was observed on a referenced example, marked on the right side of the magazine housing of the receiver/frame and on the left side of the firearm.

Model

- introduced in 2015.
- model designation "MODEL MODERN VARMINT" was observed marked on the right side of the magazine housing of the receiver/frame.
- features include: 3.6mm Wyde (long feedback) Chamber; free floating, round, stainless steel, heavy barrel; tung alloy barrel; no sights; integral sight rail on upper receiver; folding charging handle located on the left side of the upper receiver; magazine mounted in front of the trigger guard; fixed grip; two position safety located on the left side of the frame/receiver above the pistol grip; collapsible stock.
- the sample receiver had an unfinished bead blasted alloy silver finish.
- the ARS Modern Varmint accepts most AR-15 parts and accessories.
- the ARS Modern Varmint uses a Timney AR-15 self-contained drop in trigger unit with single hammer pin mounting system. The rear of the trigger unit is retained by a screw that is accessed by removing the pistol grip.
- the trigger well in the lower receiver is machined to fit mil-spec AR-15 trigger and hammer parts, however this particular firearm receiver has a self-contained trigger mechanism which mounts on the hammer axis pin, there is no trigger pin hole in the receiver.
- the ARS Model - Modern Varmint upper receiver does not have a cut for an automatic sear and has a different system for mounting upper to lower receivers than either the AR-10 or AR-15 rifles.
- overall length of firearm butt extended 955mm.

Other Markings

- the trade name "Alberta Tactical Rifle" may be found marked upon the left side of the upper receiver.
- a stylized maple leaf and the word "CANADA" may be found marked on the right side of the upper receiver to the rear of the ejection opening.

Firearms Reference Table, Specialized Policing Services, Royal Canadian Mounted Police, FRT Version 1.0, January 2020. All rights reserved. RCMP, 1998-2020.



Shots

- detachable box magazine.
- firearm designed to utilize AR15/M16 STANAG "type" cartridge magazines.

Serial Number Comments

- serial number reidentification as follows: - the ATTS prefix is an abbreviation of the manufacturer's brand name: Alberta Tactical Rifle Supply, followed by 2 digits indicating the year of manufacture, followed by the Roman alphabet letters "NW" denoting the Model: Modern Variant, with the final six (6) digits forming the firearm's unique serial number within the modern variant series production.
- serial number was observed marked on the right side of the magazine housing of the lower receiver/frame.
- observed serial number consisted of a four letter prefix followed by a series of letters and numbers.

Images



FRT Report
FRT 1.0.0 - 2019-11-25
Report Layout Version 1.0

Firearm Reference Number: 182445

Printed Date: 2020-05-15
Page: 5 / 9
Last Updated Date: 2020-05-15

Image: 1 of 5
Image Description: Full View: Left Side

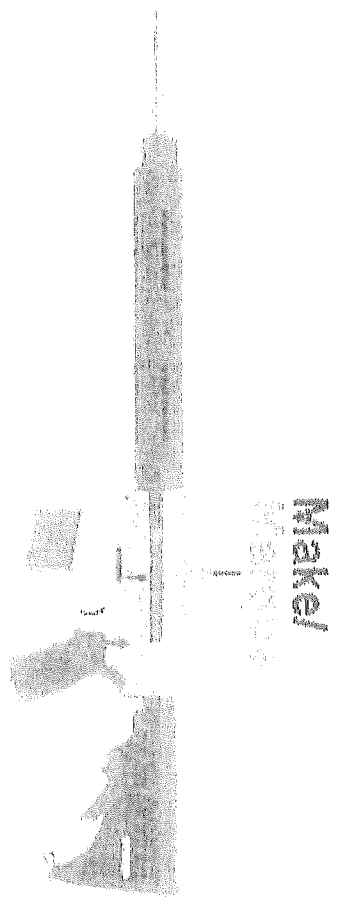

Firearms Reference Table, Specialized Folicing Services, Royal Canadian Mounted Police, FRT Version 1.0, January 2020. All rights reserved. RCMP, 1998-2020.

083

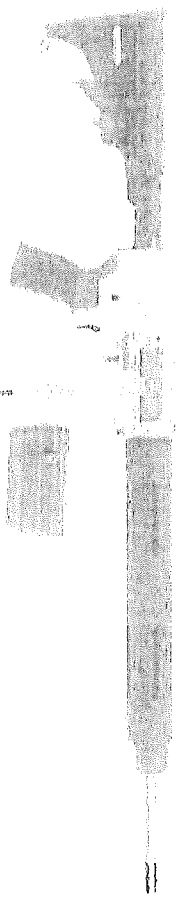

Manuf./ Modél/
Fabr. Modèle
Serial No./
No de série



FRT Report
FRT 1.0.0 - 2019-11-25
Report Layout Version 1.0

Firearm Reference Number: 162446

Printed Date: 2020-05-15
Page: 7 / 9
Last Updated Date: 2020-05-15

Image: 3 of 5
Image Description: Close-up: Left Side

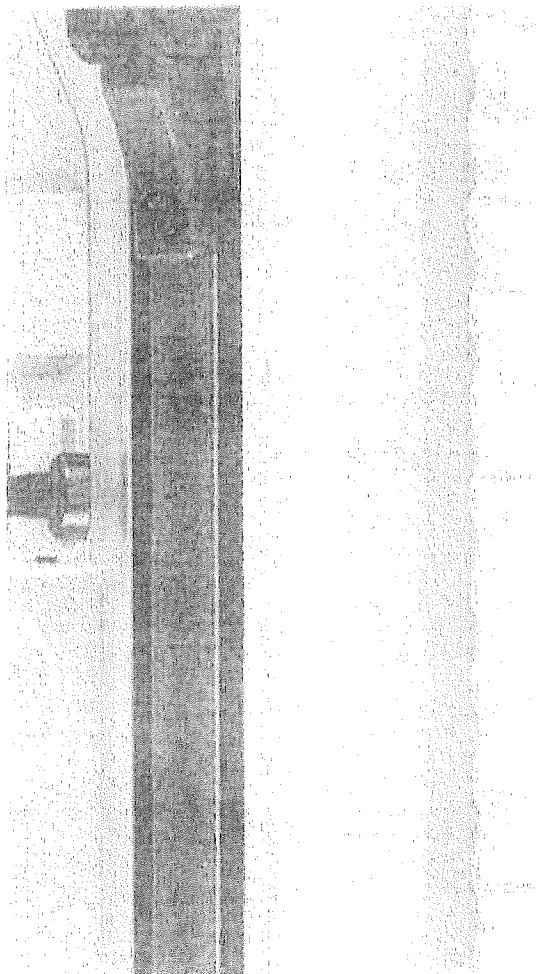

Firearms Reference Table, Specialized Policing Services, Royal Canadian Mounted Police, FRT Version 1.0, January 2020. All rights reserved, RCMP, 1398-2020.



FRT Report
FRT 1.0.0 - 2019-11-25
Report Layout Version 1.0

Firearm Reference Number: 162446

Printed Date: 2020-05-15
Page: 8 / 9
Last Updated Date: 2020-05-15

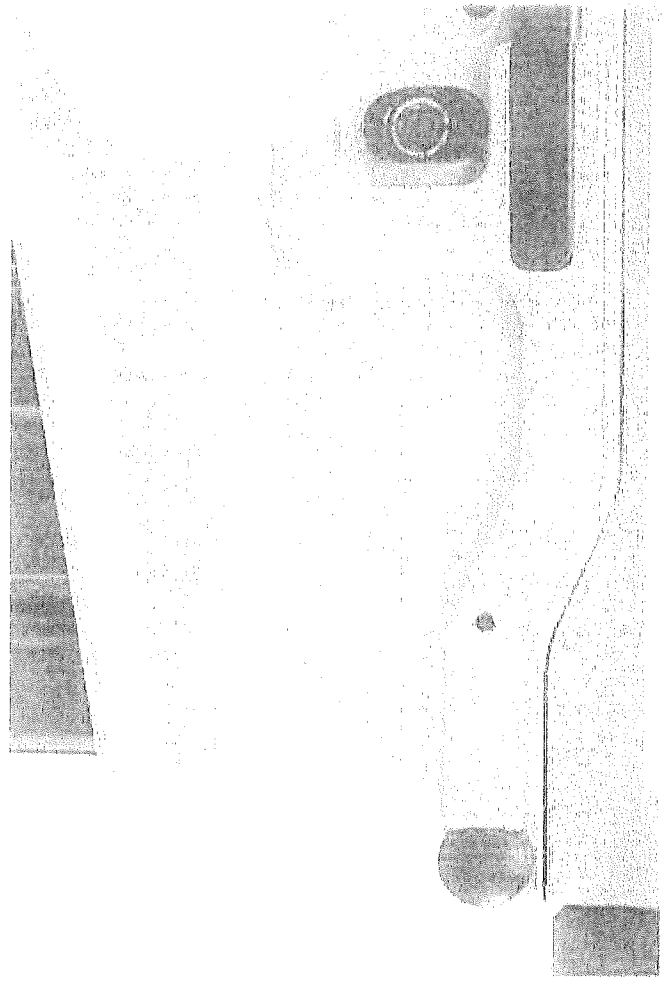

Image: 4 of 5
Image Description: Close-up #1: Right Side



FRT Report
 FRT 1.0.0 - 2019-11-25
 Report Layout Version 1.0

Firearm Reference Number: 162446

Printed Date: 2020-05-15
 Page: 9 / 9
 Last Updated Date: 2020-05-15

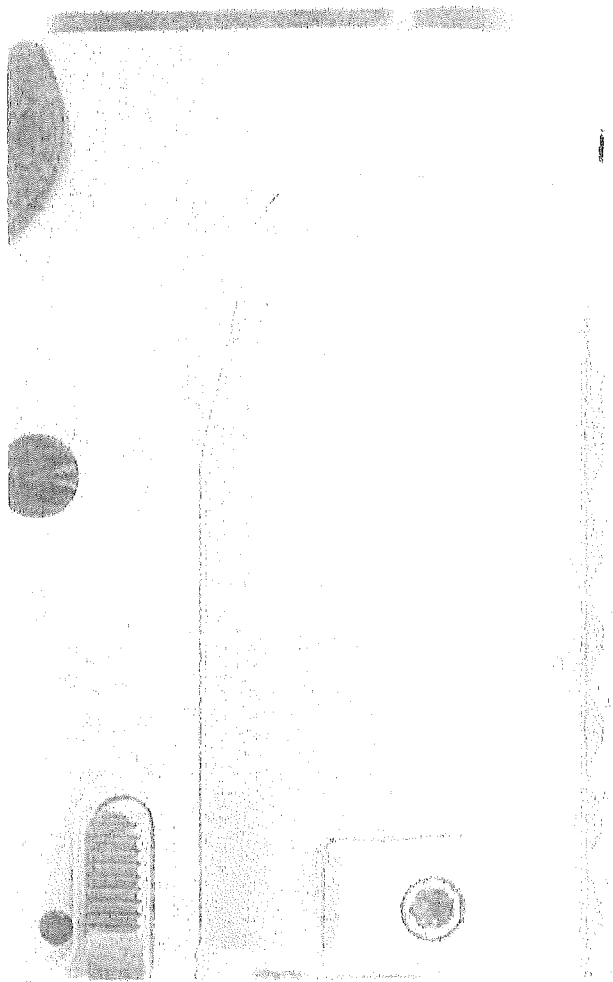

Image: 5 of 5
 Image Description: Close-up #2, Right Side

This is **Exhibit "J"** referred to in the Affidavit of Rick Timmins, sworn before me this 10 day of September, 2020.



A Commissioner for Oaths in and for the
Province of Alberta



FRT Report

FRT 1.0.0 - 2019-11-25

Report Layout Version 1.0

Firearm Reference Number: 194622

Printed Date: 2020-06-11

Page: 1 / 4

Last Updated Date: 2020-05-19

Summary

Make: Alberta Tactical Rifle
Model: Modern Spotter
Manufacturer: Alberta Tactical Rifle
Country of Manufacturer: Canada
Type: Rifle
Action: Semi-Automatic
Legal Classification: Prohibited
 (Frame or Receiver Only)
Category: Manufacturer Specifications and Commercial Customization

Calibre, Shots and Barrel Lengths

Sub-FRN	Calibre	Shots	Barrel Length (mm)	Legal Classification <small>Legal Authorities</small>	Barrel Type	Prohibited Devices	Category
194622-4	22 LR	5	305	Prohibited <small>• PFR, Part 1, para. 87</small>			Manufacturer Specifications and Commercial Customization
194622-3	22 LR	5	356	Prohibited <small>• PFR, Part 1, para. 87</small>			Manufacturer Specifications and Commercial Customization
194622-2	22 LR	5	406	Prohibited <small>• PFR, Part 1, para. 87</small>			Manufacturer Specifications and Commercial Customization
194622-1	5.56MM NATO	5	480	Prohibited <small>• PFR, Part 1, para. 87</small>			Manufacturer Specifications and Commercial Customization

Features Chart

No data



FRT Report
 FRT 1.0.0 - 2019-11-25
 Report Layout Version 1.0

Firearm Reference Number: 194622

Printed Date: 2020-06-11
 Page: 2 / 4
 Last Updated Date: 2020-05-19

Importers

No data

Also Known As/Product Code

ATR MODEL MODERN SPORTER
 ATR MODERN SPORTER
 ATRS MODEL MODERN SPORTER
 ATRS MODERN SPORTER
 MODEL MODERN SPORTER

Cross References

FRN	Make	Model	Manufacturer	Type	Action
149826	Alberta Tactical Rifle	Modern Hunter	Alberta Tactical Rifle	Rifle	Semi-Automatic
162746	Alberta Tactical Rifle	Modern Varmint	Alberta Tactical Rifle	Rifle	Semi-Automatic

Year Date

No data

Notes

Action

- gas operated

Firearms Reference Table, Specialized Policing Services, Royal Canadian Mounted Police, FRT Version 1.0, January 2020. All rights reserved, RCMP, 1998-2020.

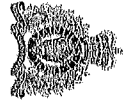

FRT Report
FRT 1.0.0 - 2019-11-25
Report Layout Version 1.0

Firearm Reference Number: 194622

Printed Date: 2020-06-11
Page: 3 / 4
Last Updated Date: 2020-05-19

Calibre

- "223 Wylde" is marked on the barrel of this firearm. This designation is not the calibre of the firearm but a description of the chamber/leade dimensions.
- the Wylde chamber is identical to the NATO STANAG chamber with a longer freebore to accommodate .224 inches (5.5MM) diameter commercial projectiles up to 80grs (5.16grm) mass. The rifling twist is 1 turn in 9 inches (1 turn in 229mm) to stabilize projectiles with a greater mass than 55 grs without incurring the pressure spike of engaging a long projectile bearing surface at full rifling depth.

Make

- the make "ALBERTA TACTICAL RIFLE" was observed on a referenced example, marked on the right side of the magazine housing of the receiver/frame and on the left side of the firearm.

Manufacturer

- the make "ALBERTA TACTICAL RIFLE" was observed on a referenced example, marked on the right side of the magazine housing of the receiver/frame and on the left side of the firearm.

Model

- introduced in 2018
- model designation "MODEL MODERN SPORTER" was observed marked on the right side of the magazine housing of the receiver/frame.
- features include: 350mm Wylde (long freebore) Chamber; free floating, round, stainless steel, heavy barrel; round alloy forging; no sights; integral sight rail on upper receiver; AR type charging handle located on top of the upper receiver; magazine mounted in front of the trigger guard; pistol grip; two position safety located on the left side of the receiver/frame above the pistol grip; collapsible stock.
- the sample firearm had an anodised mate Black finish.
- the AR15 Modern Sporter accepts most AR-15 parts and accessories.
- the trigger well in the lower receiver is machined to fit mil-spec AR-15 trigger mechanism.
- the AR15, Model - Modern Sporter upper receiver does not have a cut for an automatic sear, and has a different system for mounting upper to lower receivers than either the AR-10 or AR-15 Rifles.
- overall length of observed firearm butt collapsed 860mm.
- overall length with a 408mm (16") barrel with collapsed stock is 775mm (30.5")
- overall length with a 359mm (14") barrel with collapsed stock is 724mm (28.5")
- overall length with a 309mm (12") barrel with collapsed stock is 673mm (26.5")

Shots

- detachable box magazine.
- firearm designed to utilize AR15/M16 STANAG "type" cartridge magazines.



FRT Report
FRT 1.0.0 - 2019-11-25
Report Layout Version 1.0

Firearm Reference Number: 194622

Printed Date: 2020-06-11
Page: 4 / 4
Last Updated Date: 2020-05-19

Serial Number Comments

- serial number rationalization as follows: - the ATRS prefix is an abbreviation of the manufacturer's brand name, Alberta Tactical Rifle Supply, followed by 2 digits - indicating the year of manufacture, followed by the Roman alphabet letters "MS" denoting the model ("Modern Sporter") with the final six (6) digits being the firearm's unique serial number within the Modern Sporter series production.
- serial number was observed marked on the right side of the magazine housing of the lower receiver/frame.
- observed serial number consisted of a four letter prefix followed by a series of letters and numbers.

Images

No data